

# TOUTE LA SIGNALÉTIQUE **INDOOR & OUTDOOR**

*Simplifiez-vous la vie !*



- SIGNALÉTIQUE EXTÉRIEURE
- DISPLAY ET PLV
- STAND D'EXPOSITION
- IMPRESSION GRAND FORMAT
- SIGNALÉTIQUE ET AMÉNAGEMENT D'ESPACE

# 2025

# Sommaire



## BEACH FLAG

PACK beachflag Résist'o	8
PACK beachflag Stabil'o	10
PACK beachflag Prim'o	11
Beachflag à la carte	12
Accessoires pour beachflag	13
Kit street	14



## TENTES PLIANTES

PACK tente pliante NOMAD'O	17
PACK tente pliante NOMAD'O PRINT	18
PACK tente pliante INDUST'O	19
PACK tente pliante INDUST'O PRINT	20
TENTE PLIANTE A LA CARTE	21

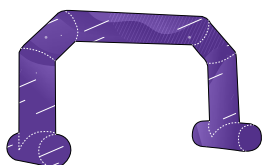

## MATÉRIEL GONFLABLE

PACK tente gonflable X ROOF 2 & EVENT ROOF	24
Arche gonflable PVC Totem event	27
Bouée nautique gonflable	29
Sky dancer	30



## MUR D'IMAGE

Photocall	33
Mur pop-up	34
Mur tubulaire droit	35
Mur tubulaire courbé	36
Mur tubulaire demi-cercle	36



## CADRE ALU /STAND

Cadre alu LED 100	38
Cadre alu LED 100 pliant	39
Cadre LED mural	40
Cadre LED expo	41
Stand modulaire nomade	42



## COMPTOIR

Comptoir pop-up	44
Comptoir tube	45
Comptoir pliant LED	46
Comptoir alu LED expo	47



## SIGNALÉTIQUE INTÉRIEURE

Roll-up standard	49
Roll-up premium	50
Roll-up double faces	51
X banner de luxe	52
Suspension pop-up	53
Table flag	54

# Sommaire



## AFFICHAGE OUTDOOR

Stop trottoir ALU 32	56
Stop trottoir à lester	57
Stop trottoir 4 en 1	58
Housse pour barrière VAUBAN	59
Barrière sur cadre	59
Barrière Pop-up	60



## IMPRESSION GRAND FORMAT

Kakemono a suspendre	62
Tifo / fond de scène	62
Pavillonnerie / drapeau publicitaire	63
Impression bâche pvc blockout & backlight	64
Impression bâche pvc & micro perforée	65
Impression tissus polyester & tissé	66
Impression film vinyle autocollant & stickers de sol	67
Impression pvc dibond, pvc akilux, pvc forex	68



## SUPPORT D'AFFICHES A POSER

Porte brochure	71
Porte brochure-comptoir	71
Chevalet	72
Porte affiche sur pied	72
Cadre sur pied	73



## SUPPORT D'AFFICHES A SUSPENDRE

Profil porte affiche	74
Cadre suspendu	74
Cadre alu d'affichage	75
Cadre d'affichage magnetique	75
Plaque de porte clip/clap	76
Affichage plexi de comptoir	76



## SUPPORTS ARDOISES

Chevalet ardoise outdoor	77
Chevalet ardoise indoor	77
Tableau ardoise	77
Ardoise de comptoir	77
Marqueur a craie liquide	77

## GUIDAGE

Poteaux de guidage avec sangle	78
Panneau pour poteau de guidage	78



## MOBILIER ÉVÉNEMENTIEL

Mange debout	81
Table pliante 180	82
Affichage table pliante 180	82
Table ronde 122	82
Housse lycra	83
Nappes	83
Visuel d' affichage pour table pliante 180	83
Chaise pliante basse	84
Chaise pliante haute	84
Housses lycra pour chaise haute	84
Parasol	85
Transat chilienne	85





## SIGNALETIQUE EXTERIEURE

---

- + BEACHFLAG / ORIFLAMMES
- + TENTES PLIANTES
- + MATERIEL CONFLABLE
- + ARCHE / TENTES





## BEACH FLAG

- + PACK beachflag Résist'o
- + PACK beachflag Stabil'o
- + PACK beachflag Prim'o
- + Beachflag à la carte
- + Accessoires pour drapeaux
- + Kit street



## PACK TOUT COMPRIS FIBRE EPOXY/CARBONE

- + Flexible
- + Résistant
- + Léger
- + Garantie à vie



Sac de transport



Léger



Sans outils

### INCASSABLE



Mât en fibre Epoxy avec 15% carbone  
Mémoire de forme et légèreté

### INTORDABLE



Roulement double cage 37mm + axe renforcé 20mm impossible à tordre et pivote avec le vent

### ERGONOMIQUE



Segments reliés et rangés dans son sac  
Impossible de perdre des éléments

### ESTHETIQUE



Forme conique et tête ajustée  
Flex parfait sans tension ni déformation

### IMPRESSION



Maille drapeau 110g avec fourreau épais  
Impression par sublimation

## COMPARAISON MÂT ALU / MÂT EPOXY

après 1 jour exposé à 30 noeuds de vent



Drapeaux en situation extrême lors du record du monde de vitesse de kitesurf avec un vent de 65 noeuds





## PACK RESIST'O **S**



Mât 250cm  
Voile 65x200cm



Platine 5kg



Sac de transport



## PACK RESIST'O **L**



Mât 350cm  
Voile 70x280cm



Platine 10kg



Sac de transport



## PACK RESIST'O **XL**



Mât 450cm  
Voile 80x400cm



Platine 15kg



Sac de transport



## MONTAGE EN 30 SECONDES

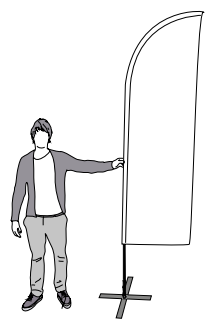
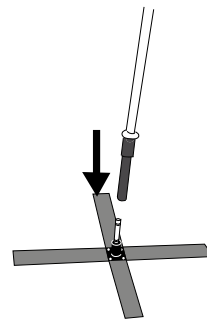
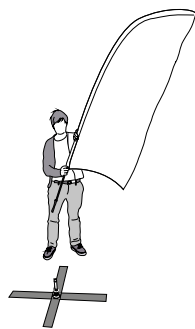
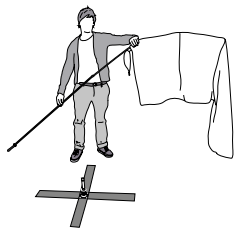
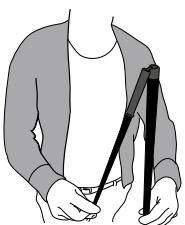



# PACK BEACHFLAG STABIL'O

Impossible à faire tomber



## PACK TOUT COMPRIS LES AVANTAGES

- + Ne tombe pas = durée de vie prolongée de 50%
- + Stable à toutes épreuves
- + Reste en extérieur toute l'année = pas de manipulation physique quotidienne



Sac de transport



Ultra léger



Sans outils



Mât fibre de verre  
Epoxy + 15% carbone  
relié par élastique



Croix 14kg avec large  
empatement de 85cm  
pour la stabilité



Roulement double  
cage 37mm et axe  
renforcé 20mm



Sac compartimenté  
pour un rangement  
et un transport pratique



Maille micro-perforée  
115g avec impression  
par sublimation

## PACK STABIL'O S



- + Mât 250cm
- + Voile 65x200cm
- + Croix extérieure 14kg
- + Sac de transport

## PACK STABIL'O L



- + Mât 350cm
- + Voile 70x280cm
- + Croix extérieure 14kg
- + Plot béton 10kg
- + Sac de transport



# PACK BEACHFLAG PRIM'O

Entrée de gamme d'excellente qualité



## PACK TOUT COMPRIS LES AVANTAGES

- + Rapport qualité/prix
- + Fourreau imprimé
- + Pack tout compris
- + Impression par sublimation

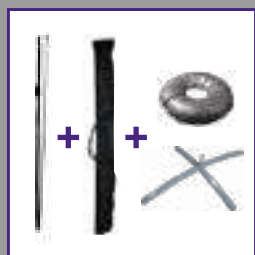

Kit tout compris  
mât + voile + croix 2kg  
avec lest à eau de 10L



Maille drapeau 110g  
avec fourreau épais  
Impression par  
sublimation

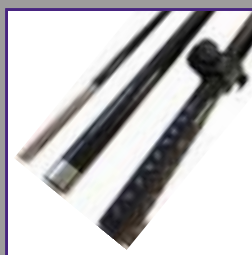

Mât avec segments  
emboîtables pour  
une utilisation  
pratique



Structure en fibre  
de verre pour allier  
souplesse et résistance



Fourreau imprimé  
façonner dans la maille  
drapeau 110g

## PACK PRIM'O S



- + Mât 240cm
- + Voile 65x200cm
- + Pied en croix 2kg
- + Lest à remplir 10L
- + Housse de transport

## PACK PRIM'O L



- + Mât 350cm
- + Voile 70x280cm
- + Pied à remplir 25kg
- + Housse de transport

## MONTAGE EN 30 SECONDES

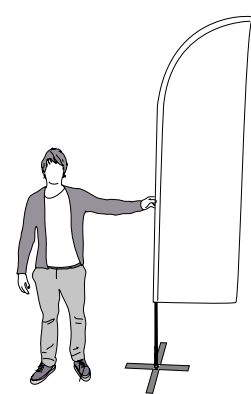
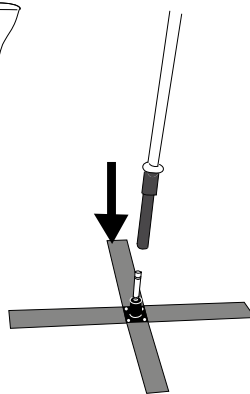
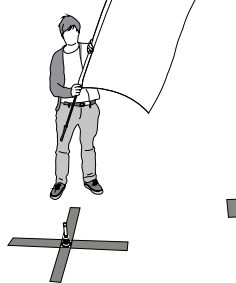
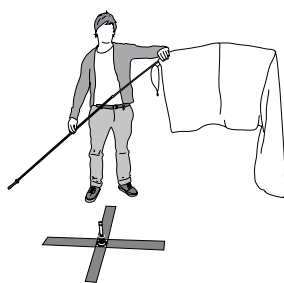
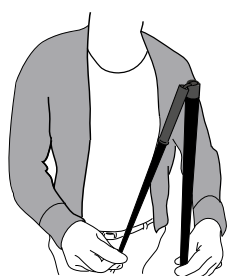

# BEACHFLAG A LA CARTE



	Finitions			Pied nomades			Pieds lourds				Spécifiques				
	Recto/verso	Fourreau imprimé	Fourreau noir	Croix de lestage pliante 2kg	Croix de lestage pliante 4kg	Plot béton 10kg	Plot parasol à remplir 15L	Plot parasol à remplir 25L	Platine 5kg	Platine 10kg	Platine 15kg	Croix de lestage 14kg	Vrille sablet et neige	Piquet a frapper	Pied autocal
<b>XS</b> (mât 225-voile 50x175)	-	✓	✓	✓	✓	-	-	-	✓	-	-	-	✓	✓	✓
<b>S</b> (mât 250-voile 65x200)	✓	✓	✓	✓	✓	✓	-	-	✓	-	-	-	✓	✓	✓
<b>L</b> (mât 350-voile 70x280)	✓	✓	✓	-	✓	✓	✓	✓	-	✓	✓	✓	✓	✓	✓
<b>XL</b> (mât 450-voile 80x400)	-	✓	✓	-	✓	-	✓	✓	-	✓	✓	✓	✓	✓	✓
<b>Giant 5 à 7m</b> (voile 400x100, 500x100, 600x100)	-	-	✓	-	✓	-	-	✓	-	-	-	✓	-	✓	-



	Recto/verso	Fourreau imprimé	Fourreau noir	Croix de lestage pliante 2kg	Croix de lestage pliante 4kg	Plot béton 10kg	Plot parasol à remplir 15L	Plot parasol à remplir 25L	Platine 5kg	Platine 10kg	Platine 15kg	Croix de lestage 14kg	Vrille sablet et neige	Piquet a frapper	Pied autocal
<b>S</b> (mât 220-voile 80x195)	✓	✓	✓	✓	✓	✓	-	-	✓	-	-	-	✓	✓	✓
<b>L</b> (mât 350-voile 100x300)	✓	✓	✓	✓	✓	✓	✓	✓	-	✓	✓	✓	✓	✓	✓
<b>XL</b> (mât 480-voile 120x350)	-	✓	✓	-	-	-	✓	✓	-	✓	✓	✓	✓	✓	✓



	Recto/verso	Fourreau imprimé	Fourreau noir	Croix de lestage pliante 2kg	Croix de lestage pliante 4kg	Plot béton 10kg	Plot parasol à remplir 15L	Plot parasol à remplir 25L	Platine 5kg	Platine 10kg	Platine 15kg	Croix de lestage 14kg	Vrille sablet et neige	Piquet a frapper	Pied autocal
<b>S</b> (mât 210-voile 75x150)	✓	✓	✓	✓	✓	✓	-	-	✓	-	-	-	✓	✓	✓
<b>L</b> (mât 300 - voile 75x250)	✓	✓	✓	✓	✓	✓	✓	✓	-	✓	✓	✓	✓	✓	✓
<b>XL</b> (mât 420-voile 75x380)	-	✓	✓	-	-	-	✓	✓	-	✓	✓	✓	✓	✓	✓
<b>Giant 5 à 6m</b> (voile 400x100,500x100)	-	-	✓	-	✓	-	-	✓	-	-	-	✓	-	✓	-

## MONTAGE EN 30 SECONDES

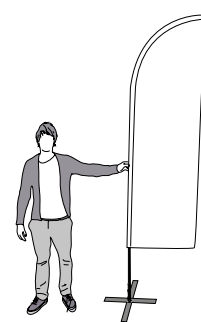
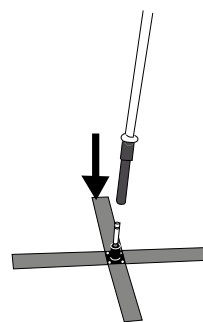
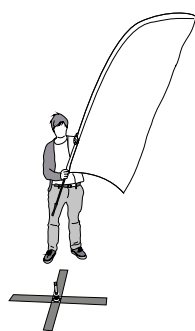
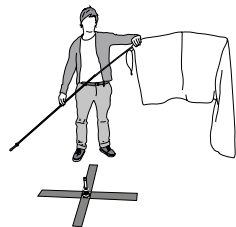
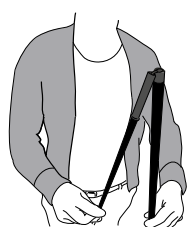



# ACCESSOIRES POUR DRAPEAUX

## PIEDS NOMADES

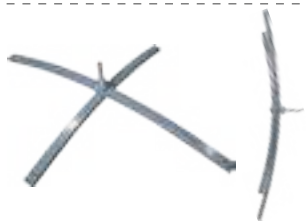

Croix lestage pliante

78 x 60 cm - 2kg



Croix lestage pliante

80 x 80 cm - 4 kg



Plot béton

ø 40 cm - 10 kg

## PIEDS LOURDS



Plot parasol à remplir

45x45cm - 15kg  
60x60cm - 25kg (avec roulettes)



Platine

40 x 40 cm - 5 kg  
40 x 40 cm - 10 kg  
50 x 50 cm - 15 kg



Croix de lestage 14kg  
pour mât giant  
14 kg

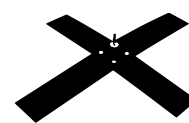

Croix de lestage 14kg

85 x 71 cm - 14 kg

## MÂTS DRAPEAUX



Mât forme SEA

XS - (225cm)  
S - 250cm  
L - 350cm  
XL - 450cm  
Giant 5,6,7m



Mât forme PLUME

S - 220cm  
L - 350cm  
XL - 480cm



Mât forme HIT

S - 210cm  
L - 300cm  
XL - 420cm  
Giant 5 à 6m

## PIEDS SPÉCIFIQUES



Vrille sable et neige

60 cm - 1 kg



Piquet à frapper

50 cm - 0.5 kg



Piquet à frapper pour  
mât giant  
50cm - 5kg



Pied autocal

55 x 50 cm - 3 kg

## LESTS POUR PIED



Plot béton pour beachflag  
pour croix extérieure 4 kg  
ø 40 cm - 10 kg



Bouée de lestage à eau  
ø 55 cm - 10 L

## OPTION TENTE PLIANTE



Fixtent pour drapeaux S

# KIT STREET

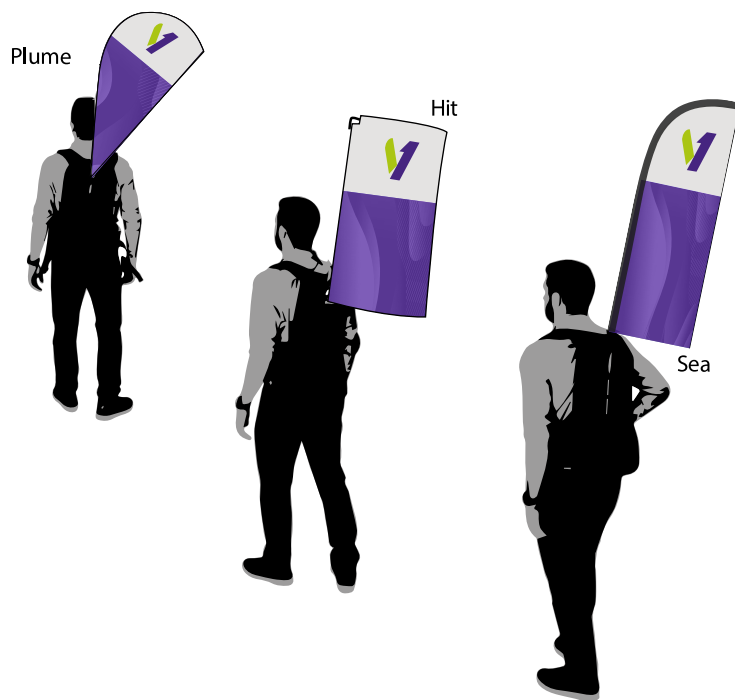

## LES AVANTAGES

- + Attire le regard
- + Idéale pour une utilisation itinérante
- + Léger et pratique
- + Qualité photo



Bretelles renforcées, ceintures réglables et poches sur le cotés



Compartiment de stockage zippé pour vos brochures et vos visuels



Système de fixation de mâts renforcés



Rangement pour les mâts et les tiges

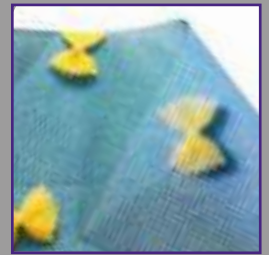

Polyester maille bloquée 115g/m<sup>2</sup> avec impression par sublimation

	Taille en cm	Mât	Voile
	SEA	93	50x127
	PLUME	93	50x98
	HIT	48x93	50x87
	BANNER	65x128	50x120

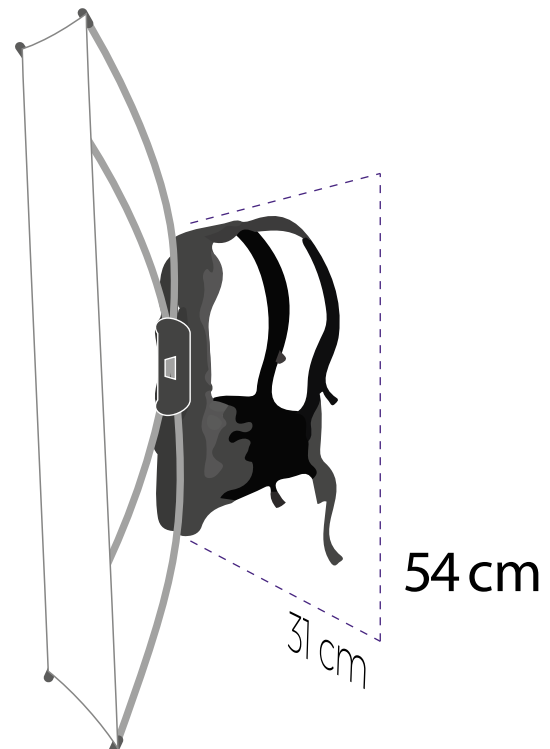









## TENTES PLIANTES

---

- + PACK tente pliante NOMAD'O
- + PACK tente pliante NOMAD'O PRINT
- + PACK tente pliante INDUST'O
- + PACK tente pliante INDUST'O PRINT
- + Tente pliante a la carte

**BEST SELLER**  
100% ALUMINIUM



Tailles de tente :

300x300cm
300x450cm
300x600cm

## LES AVANTAGES

- + 100% imprimable en sublimation  
Structure alu légère et résistante
- + Montage facile en 3 mn
- + Transportable dans une voiture  
avec son sac pochon + platines à roulette
- + Pour une utilisation événementielle



Sac de transport



Montage en 3min



Sans outils



Tube alu hexagonal  
45mm de largeur et  
1.5mm d'épaisseur



Pièce de jonction  
en nylon haute  
densité



Bague de blocage  
pull in avec réglage sur  
5 niveaux de hauteur



Embase en métal de  
11 mm de largeur et  
3 mm d'épaisseur



Polyester pelliculé PVC  
300g/m<sup>2</sup> avec impression  
par sublimation

## PACK TOUT COMPRIS



Structure alu 45  
avec toit couleur



Hauban  
léger



**NEW!** Sac pochon  
+ platines à roulette

## OPTIONS COMPLÉMENTAIRES

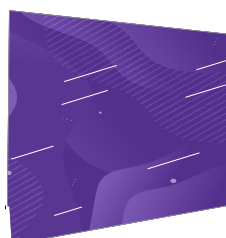

Face imprimée par  
sublimation : 3M, 4.5M, 6M

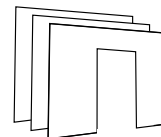

Pack faces latérales  
3 pleines + 1 porte  
3m-4.5m-6m



4 lests en fonte  
de 15kg



Sac de lest  
à remplir avec sable - 30kg  
à remplir avec eau - 15L



Lampe led



Chauffage

# PACK TENTE PLIANTE NOMAD'O PRINT



## PACK TOUT COMPRIS

### LES AVANTAGES

- + Structure en aluminium léger et résistant
- + Montage facile en 3 min
- + Transportable facilement avec son sac pochon + platines à roulette
- + Utilisation professionnelle : associations, commerçants...

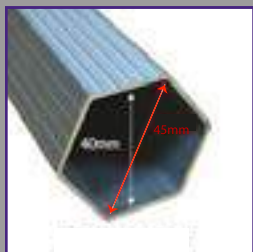

Tube alu hexagonal 45mm de largeur et 1.5mm d'épaisseur



Pièce de jonction en nylon haute densité



Bague de blocage pull in avec réglage sur 5 niveaux de hauteur



Embase en métal de 11 mm de largeur et 3 mm d'épaisseur



Polyester pelliculé PVC 300g/m<sup>2</sup> avec impression par sublimation

## PACK TOUT COMPRIS

## OPTIONS COMPLÉMENTAIRES



Structure alu 45 avec toit couleur impression en double



Hauban léger



**NEW!** Sac pochon + platines à roulette

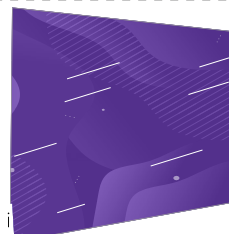

Face imprimée par sublimation : 3M, 4.5M, 6M

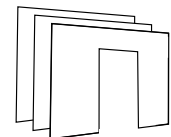

Pack faces latérales 3 pleines + 1 porte 3m-4.5m-6m



4 lests en fonte de 15kg



Sac de lest à remplir avec sable - 30kg à remplir avec eau - 15L



Lampe led



Chauffage



**PACK TOUT COMPRIS**

LES AVANTAGES

- + Qualité industrielle
- + Structure garantie à vie
- + Installation semi-permanente
- + Bâche PVC 520g ignifugée M2
- + Utilisation professionnelle :  
terrasse de restaurant,  
abris de chantier,  
espace de stockage...



Tube alu hexagonal 55mm de largeur et 1.8mm d'épaisseur



Pièce de jonction en aluminium ultra résistante



Bague de blocage pull in avec réglage sur 5 niveaux de hauteur



Embase en métal de 14mm de largeur et 3mm d'épaisseur

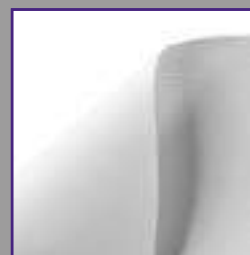

PVC 520g/m<sup>2</sup> avec ignifugation réglementée M2

PACK TOUT COMPRIS



Structure alu55 3x3 avec toit PVC 520g/m

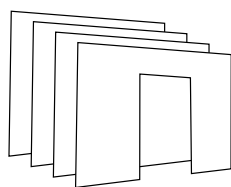

Faces PVC 3 pleines + 1 porte



Haubannage sardines pro



Sac de transport sur roulettes

OPTIONS COMPLÉMENTAIRES

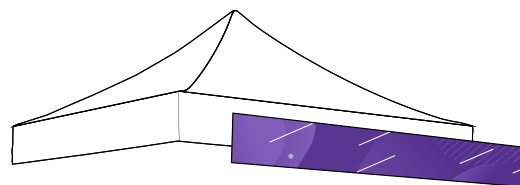

Bandeau amovible imprimé à fixer par velcro



4 lests en fonte de 15kg



Sac de lest à remplir 30kg

**LA TENTE  
HAUT DE GAMME**



**PACK TOUT COMPRIS**

LES AVANTAGES

- + Qualité industrielle
- + Structure garantie à vie
- + Installation semi-permanente
- + Toit PVC 520g imprimé
- + Utilisation professionnelle :  
terrasse de restaurant,  
abris de chantier,  
espace de stockage...



Sac de transport



Montage facile en 3min



Sans outils

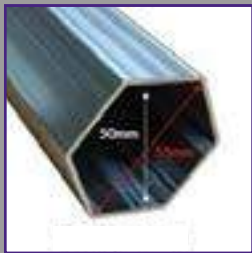

Tube alu hexagonal 55mm de largeur et 1.8mm d'épaisseur



Pièce de jonction en aluminium ultra résistante



Bague de blocage pull in avec réglage sur 5 niveaux de hauteur



Embase en métal de 14mm de largeur et 3mm d'épaisseur



PVC 520g/m<sup>2</sup> avec ignifugation réglementée M2

PACK TOUT COMPRIS



Structure alu55 3x3 avec toit PVC 520g/m



Hauban léger



Sac de transport sur roulettes

OPTIONS COMPLÉMENTAIRES

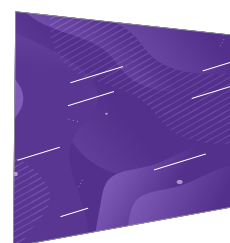

Face PVC imprimée par sublimation



4 lests en fonte de 15kg



Sac de lest à remplir 30kg

# TENTE PLIANTE A LA CARTE

## CARACTÉRISTIQUES TECHNIQUES

Dimensions (m)	2x2	3x3	3x4,5	3x6	4x4
NOMADO (ALU 45)	✓	✓	✓	✓	
INDUSTO (ALU 55)		✓	✓	✓	✓

En stock

NOMADO (ALU 45)											
INDUSTO (ALU 55)											

## HABILLAGE & IMPRESSION

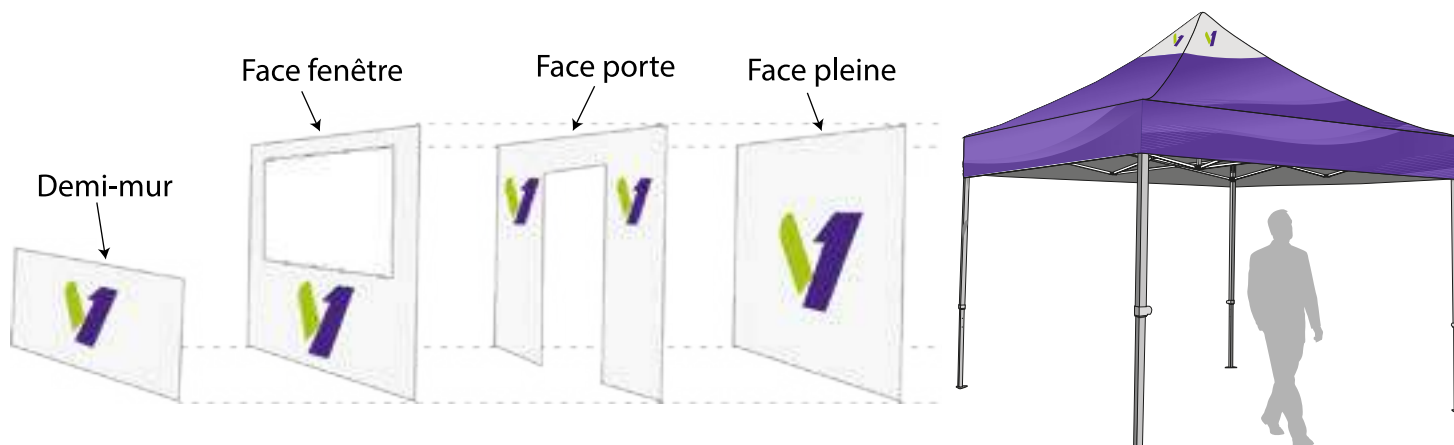

## ACCESSOIRES



Poids de lestage

Fonte d'acier - 15kg



Sac de lestage

A remplir de sable - 30kg  
A remplir d'eau - 15L



Haubans

Sardines + 3m de corde



Gouttière

3 m, 4,5m ou 6m



Chauffage

3 x 500w



Eclairage LED

3 x 10w







## MATÉRIEL GONFLABLE

---

- + PACK tente gonflable X ROOF 2 & EVENT ROOF
- + Arche gonflable PVC Totem event
- + Bouée nautique gonflable
- + Sky dancer



# PACK TENTE GONFLABLE X ROOF 2

## LES AVANTAGES



Tailles de tente :
300x300cm
400x400cm
500x500cm
600x600cm
800x800cm

- + Tente gonflable : one pump
- + 22 ans d'évolution
- + Qualité professionnelle
- + Résiste aux conditions extrêmes (vent fort, sable, neige)
- + Air captif (sans soufflerie permanente 220V)
- + Transportable dans son sac de transport
- + Gros diamètre de boudin en structure Dacron



Sac de transport



Montage en 10 min



Sans outils



Système de gonflage/dégonflage one pump



Monobloc souple 100% conçu pour éviter les matériaux rigides



Valve 1/4 tour anti retour haut débit



Chambre à air en TPU



Toit en tissu polyester étanche et ignifugé B1 pour respecter les normes

## ACCESSOIRES INCLU



Haubanage X4 (cordes + piquets)



Pompe manuelle



Sac de transport

## ACCESSOIRES EN OPTION



Pompe 220V (compatible pour tous le gonflable)



Sac de lestage à remplir avec du sable ou de l'eau



Tube de renfort latéral (pour le vent fort)



Lampe led



# PACK TENTE GONFLABLE EVENT ROOF

MODÈLE BREVETÉ  
DEPUIS 2005



BREVET EU N°1504432  
USA N°7.552.555 B2

Tailles de tente :

300x300cm

400x400cm

500x500cm

600x600cm

800x800cm

## LES AVANTAGES

- + Légereté
- + Qualité professionnelle
- + Rapidement montable
- + Air captif (sans soufflerie permanente 220V)



Sac de transport



Montage facile  
en 10min



Sans outils



Structure au dacron  
pour assurer une  
résistance maximale



Boudin indépendant  
interchangeable



Valve 1/4 tour  
anti retour haut débit



Chambre à air en  
TPU



Toit en tissu polyester  
étanche et ignifugé B1  
pour respecter les normes

## ACCESSOIRES INCLU



Haubanage X4  
(cordes + piquets)



Pompe  
manuelle



Sac de transport

## ACCESSOIRES EN OPTION



Pompe 220V  
(compatible pour tous  
le gonflable)



Sac de lestage à remplir  
avec du sable ou de l'eau



Lampe led

# OPTIONS D'IMPRESSION TENTE

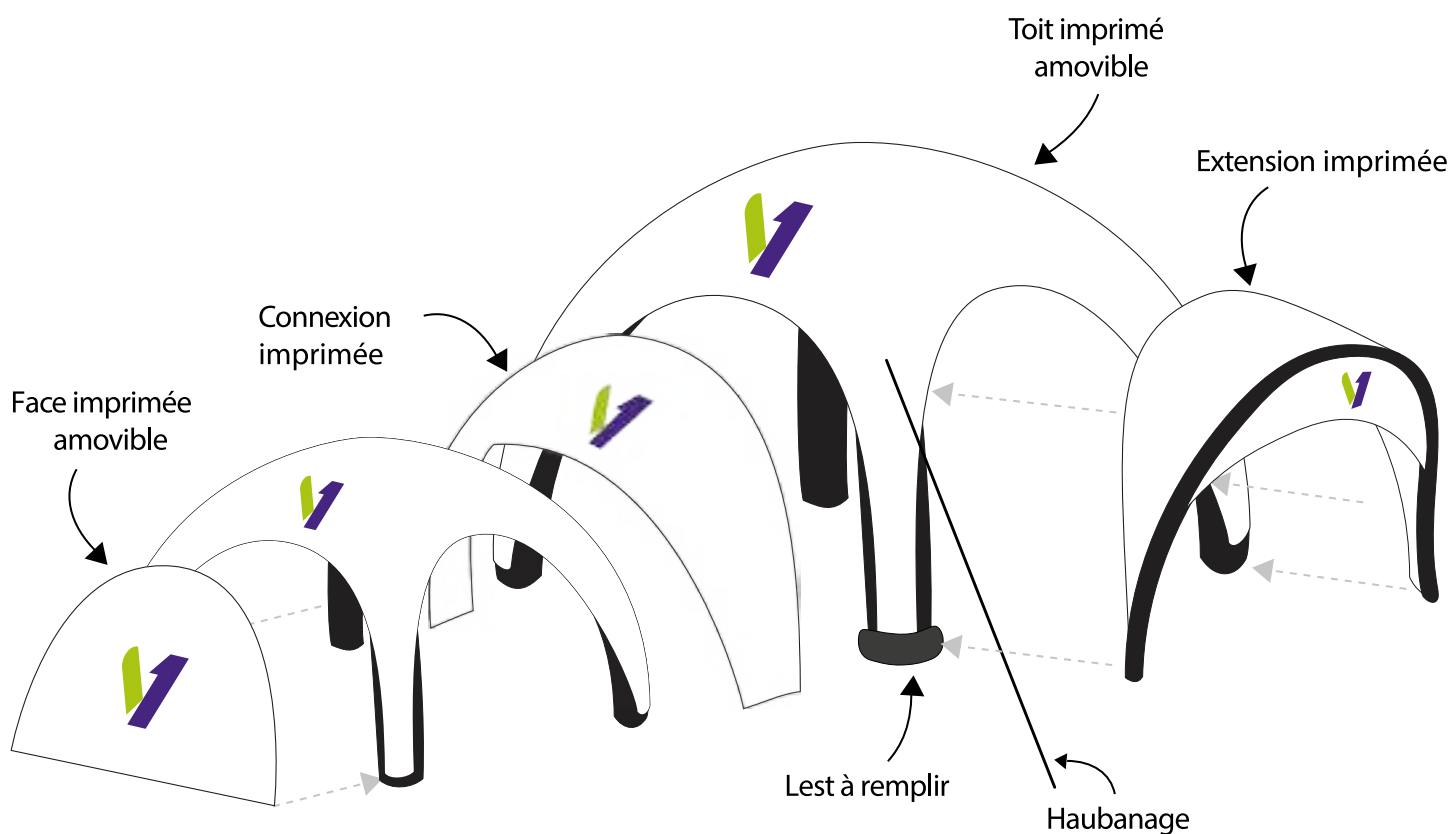

Taille	dimensions au sol	Hauteur totale	Hauteur de passage (mur)	Temps de gonflage	Poids [kg] tente complète
3X3	3.2	2.4	1.9	5	30
4X4	3.95	2.7	2	8	36
5X5	4.85	3.3	2.5	10	40
6X6	5.8	3.9	3	15	50
7X7	6.8	4.7	3.2	20	68
8X8	7.8	5.4	3.58	25	118

Différentes faces latérales :

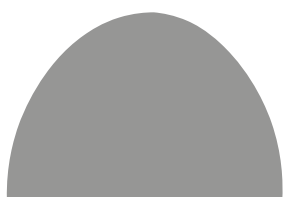

Face pleine



Face fenêtre

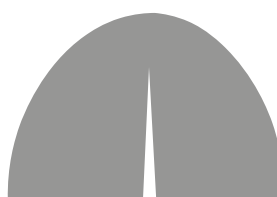

Face porte



Extension

# ARCHE GONFLABLE PVC

## LES AVANTAGES

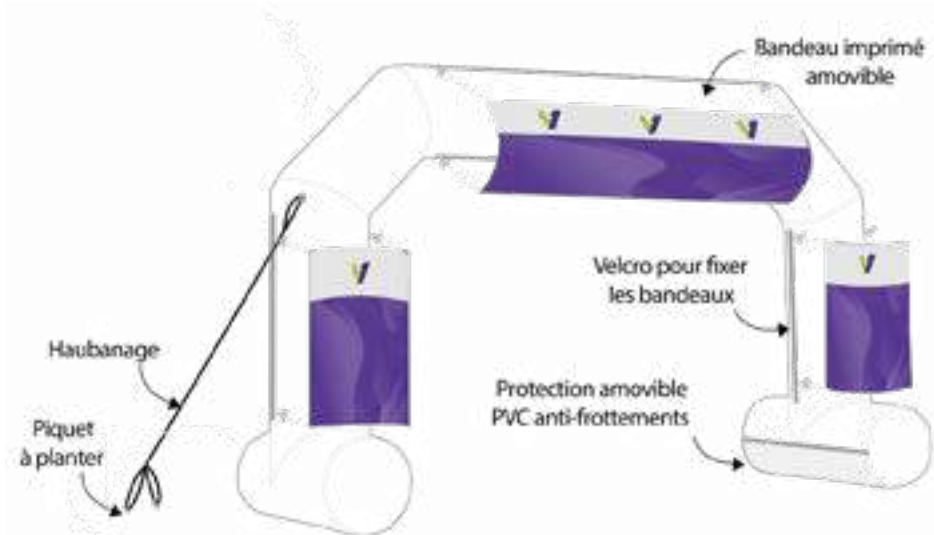

- + Impression directe ou amovible
- + Qualité professionnelle
- + Résiste au vent
- + Léger et pratique
- + Air captif (sans soufflerie permanente 220V)



Structure en PVC  
680g/m<sup>2</sup> étanche



Plusieurs points  
d'encrage pour plus  
de résistance



Valve 1/4 tours  
anti retour haut débit

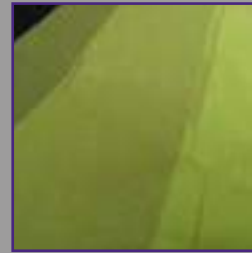

Impression  
directement sur  
le PVC à la demande



Bandeaux amovibles  
fixés par velcro avec  
impression sublimation

## IMPRESSION & PERSONNALISATION

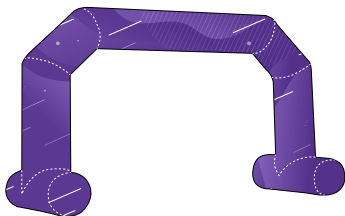

100% imprimé

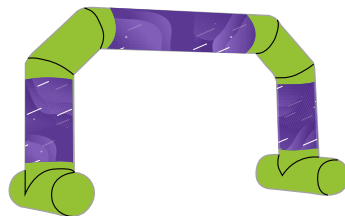

Couleur standard  
avec bandeaux

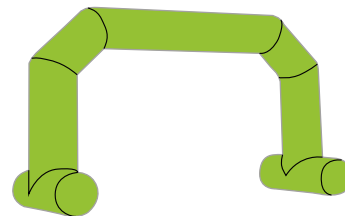

Couleur standard  
sans personnalisation



Coloris standards

## DIFFERENTES TAILLES

Taille en m	Dimensions extérieures	Dimensions intérieures
<b>S3</b>	4.6x3	3x2.2
<b>M5</b>	6.6x4.3	5x3.5
<b>L6</b>	8x5	6x4
<b>XL8</b>	10x5	8x4

		Tailles bandeaux			
	Bandeaux horizontal	<b>S3</b>	<b>M5</b>	<b>L6</b>	<b>XL8</b>
	Bandeaux vertical	<b>S3</b>	<b>M5</b>	<b>L6</b>	<b>XL8</b>



# TOTEM EVENT

## OPTIONS :

Kit d'aubannage



POMPE 220V

(compatible pour tous type d'embout)



## LES AVANTAGES

- + Qualité professionnelle
- + Résiste aux conditions extrêmes (vent 90km/h) avec haubannage
- + Air captif (sans soufflerie permanente 220V)



Sac de transport



Montage facile en 5min



Sans outils



Valve anti retour haut débit



Monobloc souple 100% cousue pour éviter les matériaux rigide



Chambre à air en TPU



Finition plate avec patins



Visuel amovible par zipper

## IMPRESSION & ACCESSOIRES

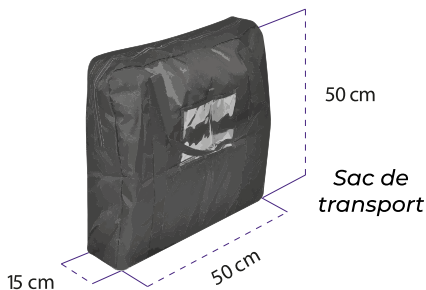

Sac de transport

15 cm

50 cm

Platine 10 kg

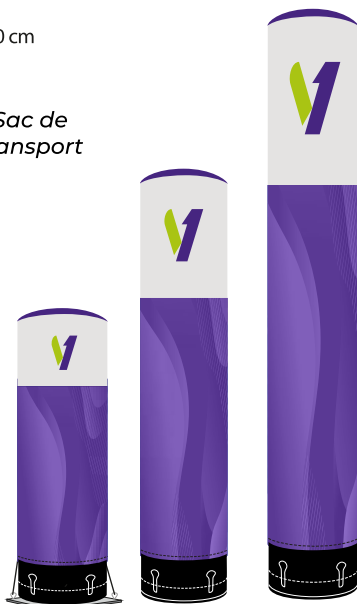

## DIFFERENTES TAILLES

Taille en m	Hauteur du visuel	Diamètre
2M	1.8	0.4
3M	2.8	0.4
4M	3.8	0.4

## FIXATIONS (en option)



Plaque de lest 10kg

# BOUÉE NAUTIQUE GONFLABLE

## OPTIONS :

Kit d'aubannage



POMPE 220V  
(compatible pour tous type d'embout)

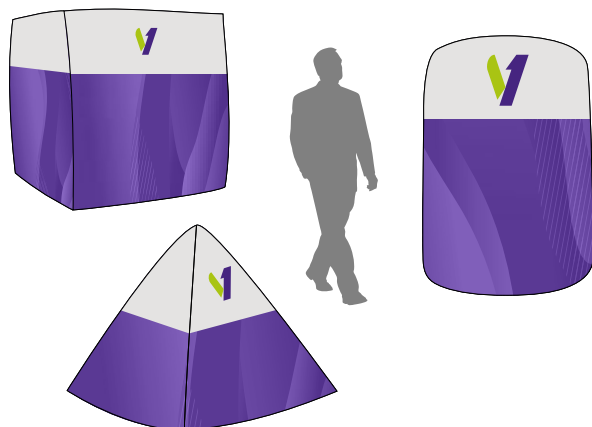

## LES AVANTAGES

- + Qualité professionnelle
- + Résiste aux conditions extrêmes
- + Air captif (sans soufflerie permanente 220V)



Sac de transport



Montage facile en 3min



Sans outils



Structure en PVC 680g/m<sup>2</sup> étanche



Plusieurs points d'encrage pour plus de résistance



Valve 1/4 tours anti retour haut débit

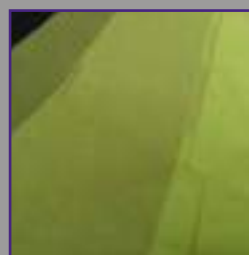

Impression directement sur le PVC à la demande



Bandeaux amovibles fixés par velcro avec impression sublimation



Forme cube  
Tailles en m

Taille en m	Largeur	Hauteur
M	1	1
L	1.5	1.5
XL	2	2



Forme tripode  
Tailles en m

Taille en m	Largeur	Hauteur
M	1.4	1
L	2.15	1.5
XL	2.9	2



Forme cylindrique  
Tailles en m

Taille en m	Largeur	Hauteur
S	0.5	0.8
M	1	1
L	1	1.5
XL	1.2	1.8

## IMPRESSION & ACCESSOIRE



Impression directe

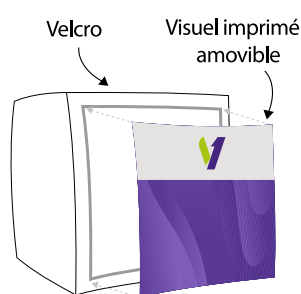

Impression amovible

Oeillets métalliques pour fixer système d'ancrage

-> système d'ancrage (non fournit)



Coloris standards

# SKY DANCER

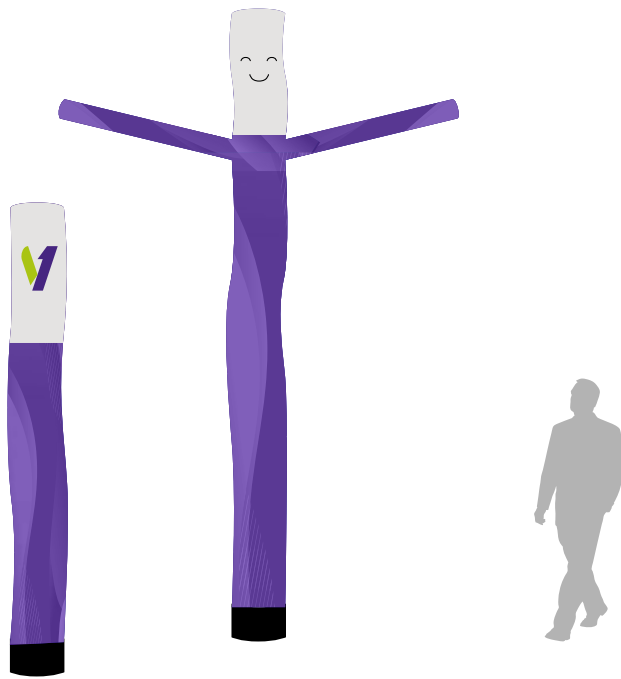

## LES AVANTAGES

- + Jusqu'à 6 m de hauteur
- + Plusieurs formes
- + Avec ou sans marquage
- + Soufflerie sur secteur



Sans  
outils



2 formes  
disponibles



Visuel amovible  
par velcro



Option LED



Soufflerie 220 volts



Déperlant

## MONTAGE EN 30 SECONDES

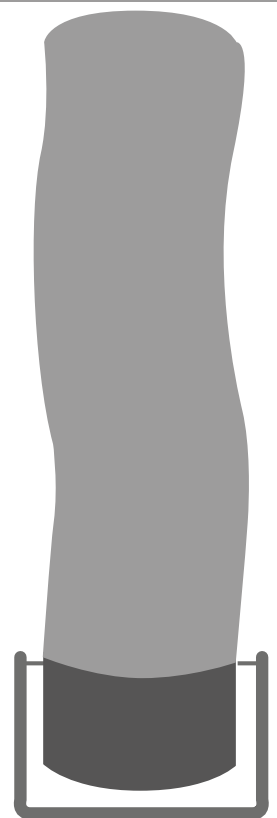
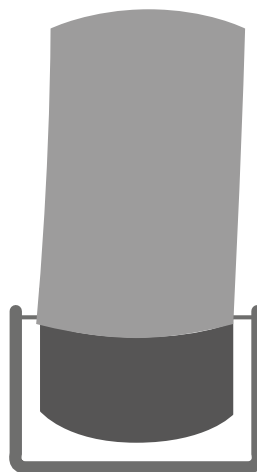
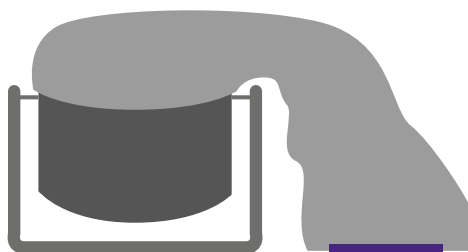
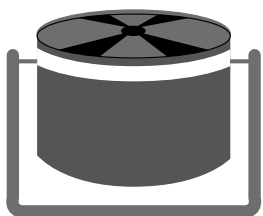





## SIGNALÉTIQUE INTÉRIEURE

- + Mur d'image
- + Cadre alu / stand
- + Comptoir
- + Affichage Indoor
- + Affichage Outdoor



## MUR D'IMAGE

---

- + Photocall
- + Mur pop-up
- + Mur tubulaire droit
- + Mur tubulaire courbé
- + Mur tubulaire demi-cercle

### LES AVANTAGES



- + Montage simple et rapide
- + Structure télescopique réglable pour s'adapter à l'espace
- + Visuel changeable en PVC ou Polyester avec 2 ourlets

-  Sac de transport
-  Ultra léger
-  Sans outils

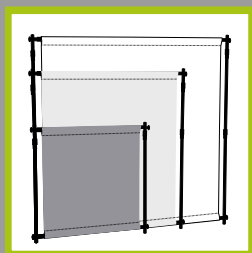

Plusieurs dimensions possible



Assemblage par molettes



Tubes telescopiques



Auto stable



Sac de transport



### Photocal

Tailles en cm

Minimum Maximum

LARGEUR	90	240
HAUTEUR	90	240

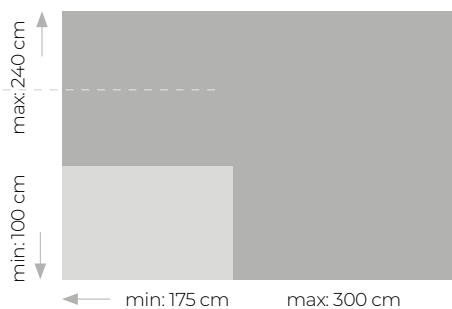

### MONTAGE EN 5MN

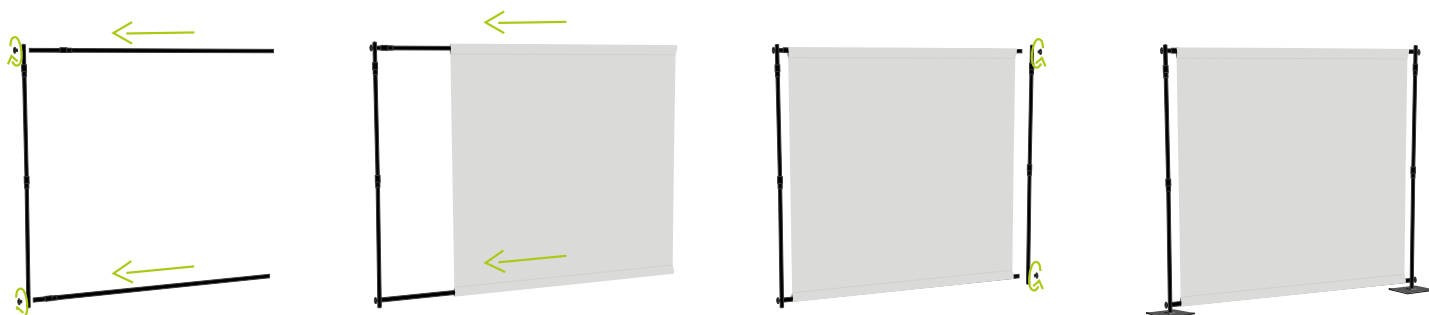



# MUR POP-UP



## LES AVANTAGES

- + Disponible en 4 formats
- + Construction légère en aluminium anodisé
- + Structure pliable sans démontage de la voile
- + Tissu élastique infroissable



Sac de transport



Sans outils



Sac de transport



Structure Compacte



Verrouillage par clips



Fixation par velcro



Structure pliable sans démontage du visuel

## ⊕ CARACTÉRISTIQUES TECHNIQUES

Type	Taille de la structure : largeur x hauteur x épaisseur [cm]	Poids [kg]
S - 1.50m	152,5 x 226 x 29,5	11
M - 2.20m	226 x 226 x 29,5	14
L - 3.00m	299,5 x 226 x 29,5	16
XL - 3.70m	373 x 226 x 29,5	18



## MONTAGE EN 3MN

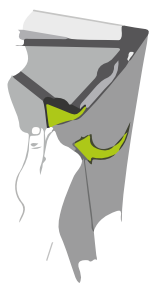
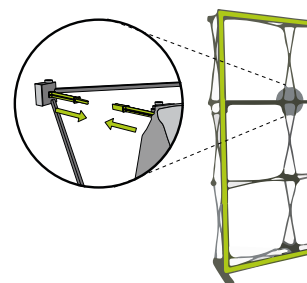

# MUR TUBULAIRE DROIT



## LES AVANTAGES

- + Montage simple et rapide
- + Donne de la profondeur à votre stand
- + Qualité photo
- + Visuel changeable
- + Impression recto-verso



Montage rapide sans outils



Montage extrêmement facile



Tube 32 mn reliés par un élastique



Sac de transport pour le ranger et le stocker facilement



Tissu polyester avec impression par sublimation

## CARACTÉRISTIQUES TECHNIQUES

Type	Taille de la structure : largeur x hauteur x épaisseur [cm]	Poids [kg]
Droit S - 250	250 x 230 x 40*	11
Droit M - 300	300 x 230 x 40*	12
Droit L - 400	400 x 230 x 40*	13
Droit XL - 590	590 x 230 x 40*	20

\* 40 cm - longueur des pieds

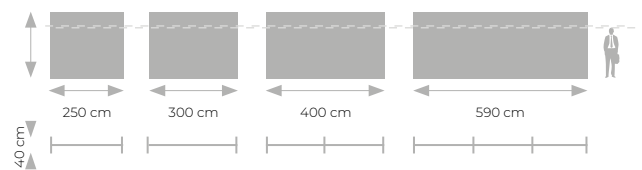

## ACCESSOIRES ETAGERES



## ACCESSOIRES PORTE BROCHURES



# MUR TUBULAIRE COURBE



## LES AVANTAGES

- + Montage simple et rapide
- + Donne de la profondeur à votre stand
- + Qualité photo
- + Visuel changeable
- + Impression recto-verso



Sac de transport



Ultra léger



Sans outils

## CARACTÉRISTIQUES TECHNIQUES

Type	Taille de la structure : largeur x hauteur x épaisseur [cm]	Poids [kg]
Courbe S- 250	250 x 230 x 40*	11
Courbe M- 300	300 x 230 x 40*	12
Courbe L - 400	400 x 230 x 40*	13
Courbe XL - 530	530 x 230 x 40*	20

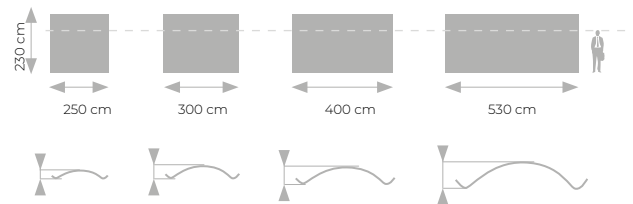

# MUR TUBULAIRE DEMI CERCLE



## LES AVANTAGES

- + Séparation d'espace privé
- + Présentation exclusive de produit



Sac de transport



Ultra léger



Sans outils

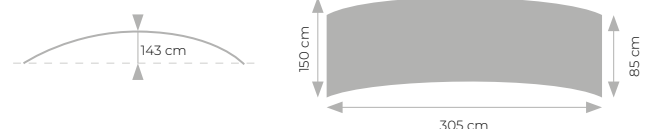





## CADRE ALU /STAND

- + Cadre alu LED 100
- + Cadre alu LED 100 pliant
- + Cadre LED mural
- + Cadre LED expo
- + Stand modulaire nomade

# CADRE LED 100

# CADRE LED 100 BLACK



## LES AVANTAGES

- + Modulaire et facile à transporter
- + Permet de créer un stand en 5 min à moindre coût
- + Impact professionnel avec une qualité photo
- + Option noir aspect « haut de gamme »



LED



Connecteur rapide



Sans outils



Profile aluminium



Double face



Sans silicone



Assemblage sans outil par clip



Zoom cadre



Zoom cadre



Mode d'emploi



Sac de transport

## ⊕ CARACTÉRISTIQUES TECHNIQUES

Type	Taille de la structure : largeur x hauteur	Poids [kg]
LED 100 S	100x200	9,2
LED 100 M	100x230	10
LED 100 XL	100x250	12

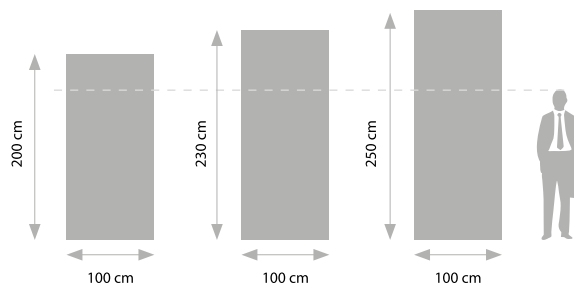

## ⊕ LES CADRES LED 100 PEUVENT SE CONNECTER ENTRE EUX POUR FORMER DES MURS DROITS OU DES ANGLES

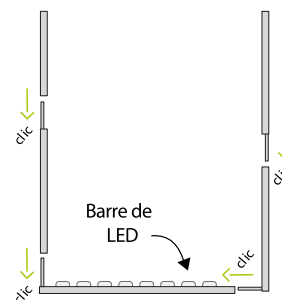
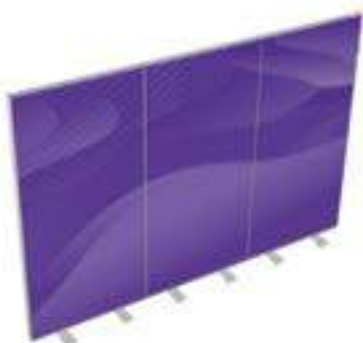

# CADRE LED 100 PLIANT



## LES AVANTAGES

- + Modulaire et facile à transporter
- + Permet de créer un stand en 5 min à moindre coût
- + Très simple à monter sans outils
- + Impact professionnel avec une qualité photo



LED



Connecteur rapide



Sans outils



Profile aluminium



Double face



Sans silicone



Pliant



## ⊕ CARACTÉRISTIQUES TECHNIQUES

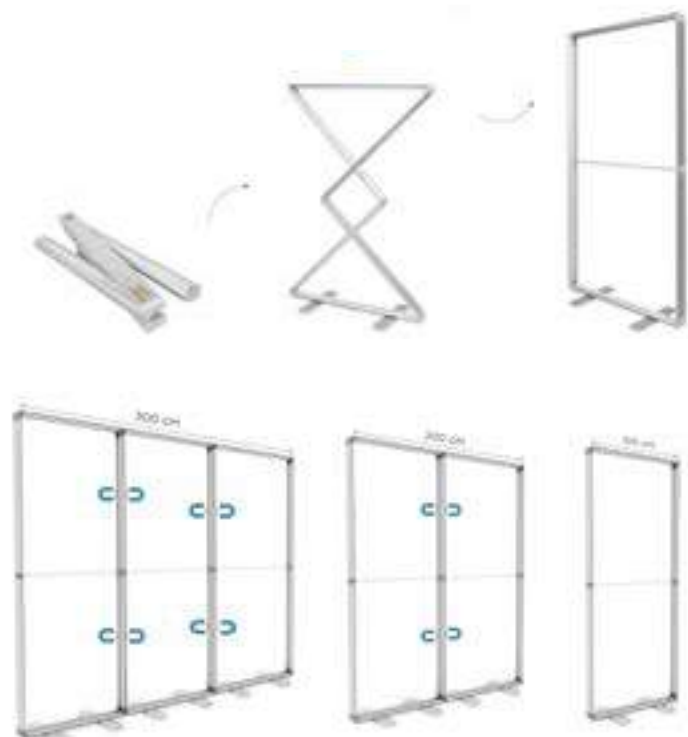
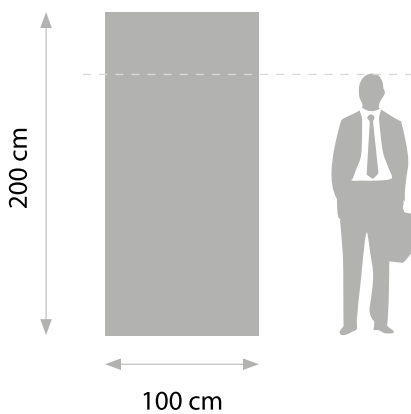



# CADRE LED MURAL



## LES AVANTAGES

- + Large surface d'impression
- + Prêt à visser au mur
- + Impression par sublimation



LED



Connecteur rapide



Sans outils



Profile aluminium



Double face



Jonc silicone



Assemblage sans outil par clip



Profilé 8 cm



Eclairage lateral en LED



Conditionnement unitaire carton



Sac de transport

## MONTAGE FACILE

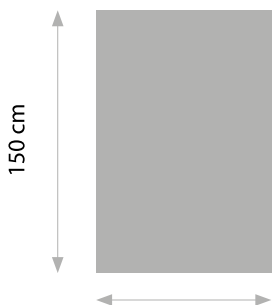

150 cm

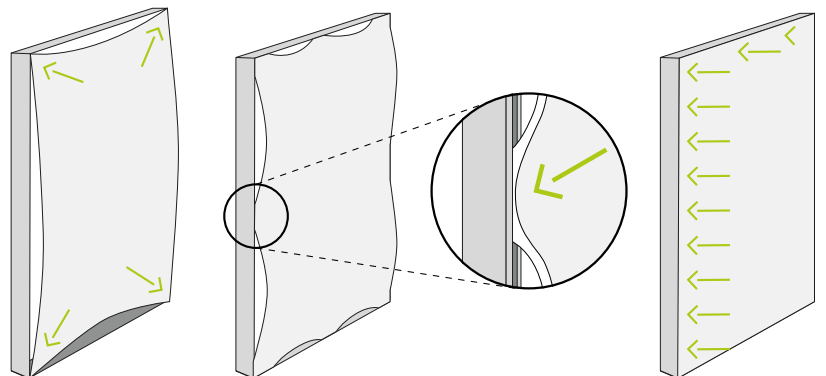

## LES AVANTAGES

- + Large surface d'impression d'un seul morceau sans poteau
- + S'adapte à votre stand, à votre point de vente ou bureau
- + Conception fixe ou nomade
- + Impression par sublimation
- + Impression recto-verso



LED



Connecteur rapide



Sans outils



8 cm  
Profile aluminium



Double face



Jonc siliconé



Assemblage sans outil par clip



Profilé 10 cm

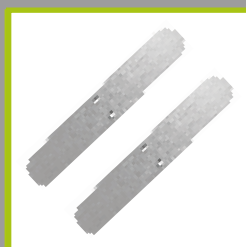

Pieds extra-large pour une stabilité à toutes épreuves



Barre de masquage pour protéger les ampoules LED



Sac rangement compartimenté pour faciliter le transport

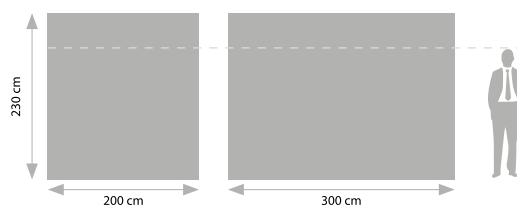
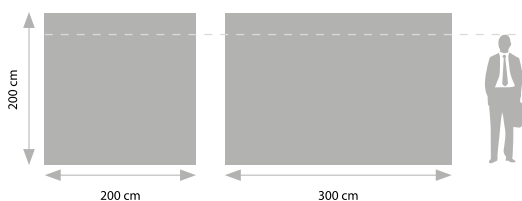

## MONTAGE FACILE

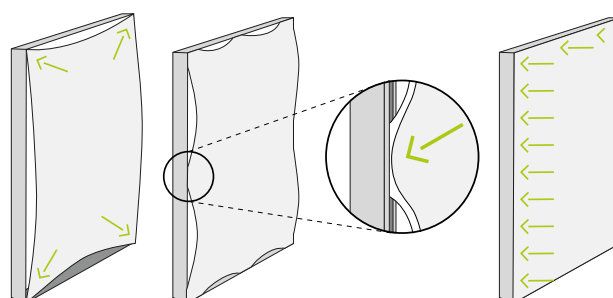

# STAND MODULAIRE NOMADE

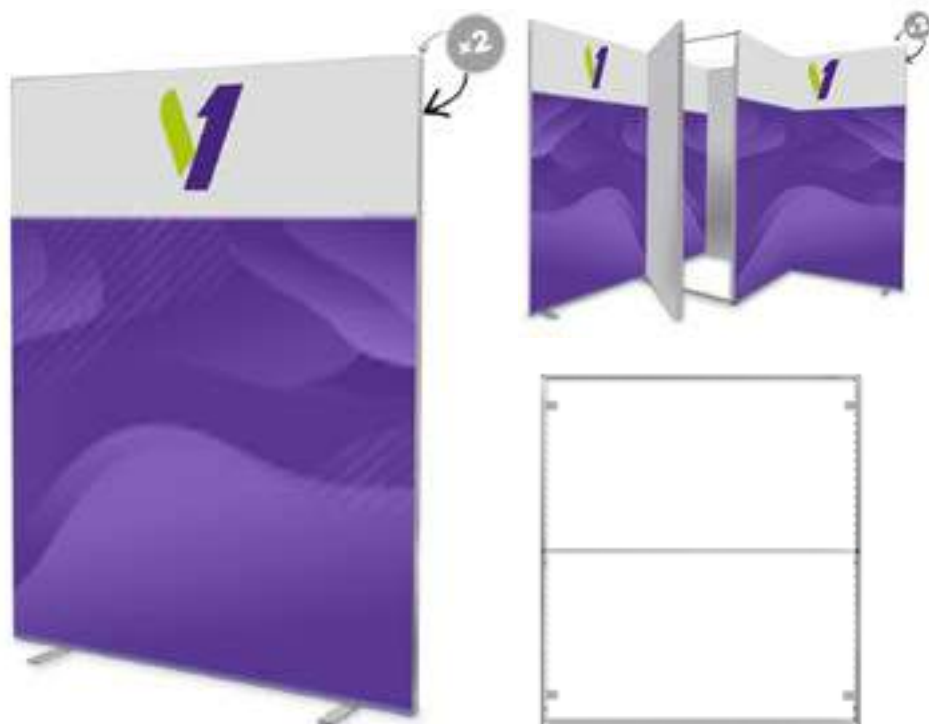

## LES AVANTAGES

- + Le module de stand peut se connecter à l'infini pour créer votre stand et l'ajuster à votre lieu d'exposition
- + Réutilisez votre stand pour les prochains lieux d'événements
- + Très simple à monter sans outils
- + Transport facile dans une voiture avec les sacs de transports



modulaire



Ultra léger



Sans outils



Profilé aluminium



Double face



Fixation par jonc siliconé



Pré-assemblé

## CARACTÉRISTIQUES TECHNIQUES

3 tailles et 3 hauteurs	Taille de la structure : largeur x hauteur	Poids [kg]
Modèle 1	100x200	2,1
Modèle 2	120x200	2,6
Modèle 3	150x200	3,2
Modèle 4	100x230	2,1
Modèle 5	120x230	2,6
Modèle 6	150x230	3,2
Modèle 7	100x250	2,1
Modèle 8	120x250	2,6
Modèle 9	150x250	3,2

## PLUSIEURS PANNEAUX MAIS AVEC UNE SEULE IMPRESSION

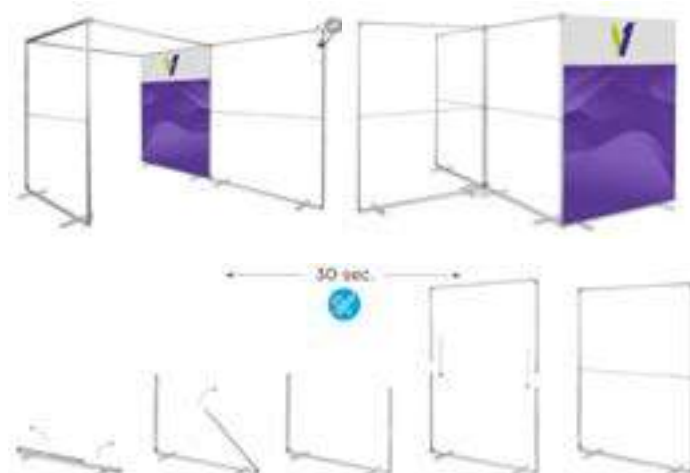

**LE KIT COMPREND :**  
UN CADRE, UN JEU DE CONNECTEURS (SÉRIE – 4 PIÈCES, SUPÉRIEUR – 1 PIÈCE, INFÉRIEUR – 1 PIÈCE), UN SAC DE TRANSPORT



En option

**SANS OUTILS - CAISSE DE CONNECTEUR POUR ASSEMBLER AUCUN ÉCART UNE FOIS MONTÉ**

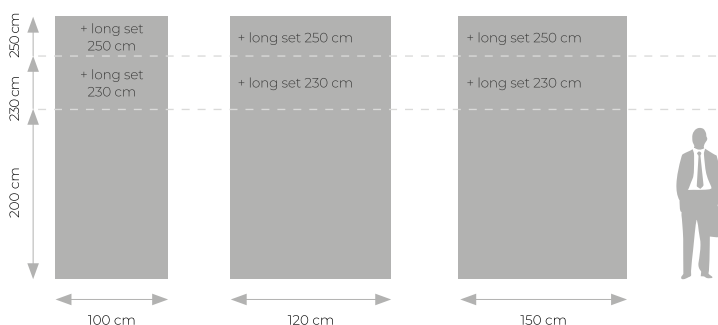





## COMPTOIR

---

- + Comptoir pop-up
- + Comptoir tube
- + Comptoir pliant LED
- + Comptoir alu LED

# COMPTOIR POP-UP

## LES AVANTAGES

- + Finalise le stand
- + Point d'accueil client
- + Nomade et pratique
- + Etagère de rangement
- + Qualité photo



Sac de transport



Monobloc léger



Sans outils



Structure aluminium verrouillée par des connecteurs



Etagère discrète pour garder un plan de travail toujours rangé



Visuel interchangeable en polyester imprimé fixer par velcro



Sac de transport

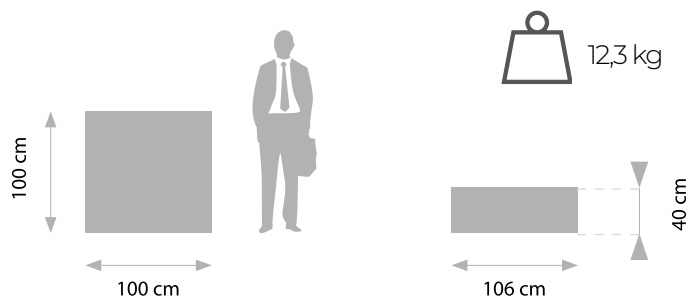

## MONTAGE EN 2 MN

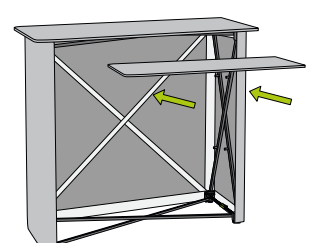
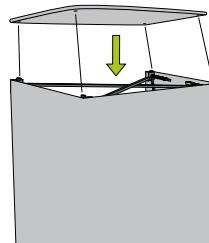
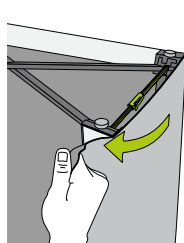
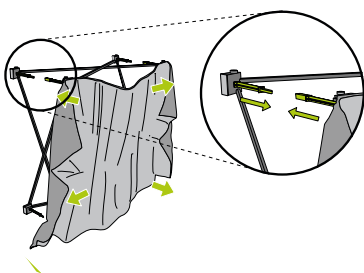

## COMPTOIR TUBE OVALE



8 kg

### ⊕ CARACTÉRISTIQUES TECHNIQUES

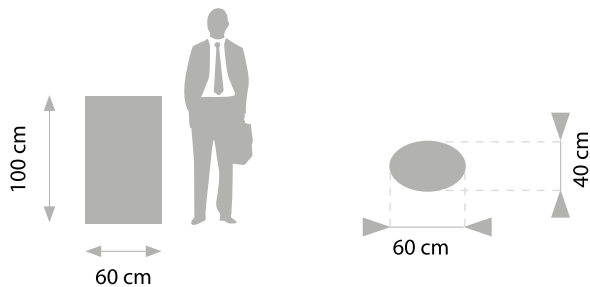

### LES AVANTAGES

- + Point d'accueil client
- + Nomade et pratique
- + Plateau bois avec rainurage pour accueillir le visuel
- + Socle métal pour plus de stabilité
- + Parfaitement tendue
- + Qualité photo
- + Fixation du visuel par jonc silicone



## COMPTOIR TUBE RECTANGLE



MONTAGE EN 2 MIN

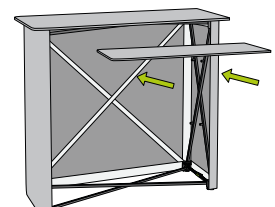
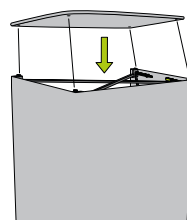
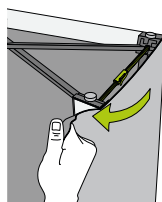
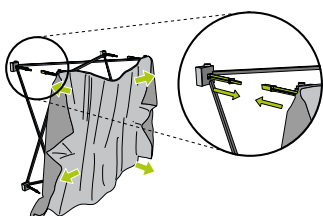
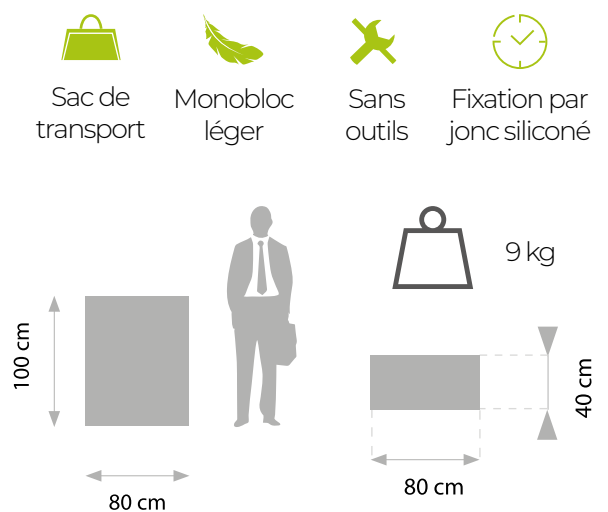

## COMPTOIR LED PLIANT OVALE



### ⊕ CARACTÉRISTIQUES TECHNIQUES

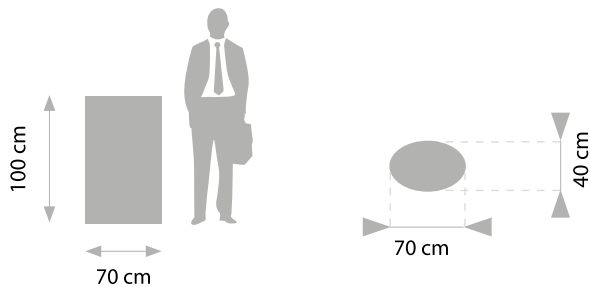

### LES AVANTAGES

- + Déploiement automatique sans outils en 1 min
- + Nomade et pratique
- + Point d'accueil client
- + Eclairage LED
- + Socle métal pour plus de stabilité
- + Parfaitement tendue
- + Qualité photo
- + Fixation du visuel par jonc silicone

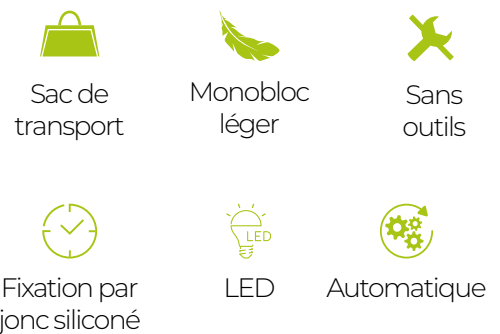

## COMPTOIR LED PLIANT RECTANGLE

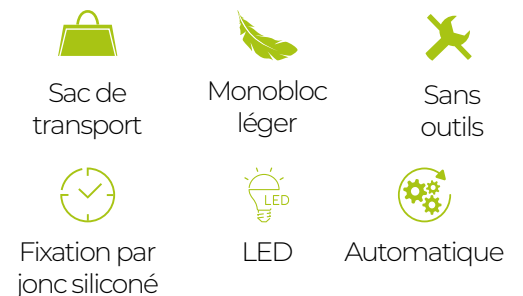
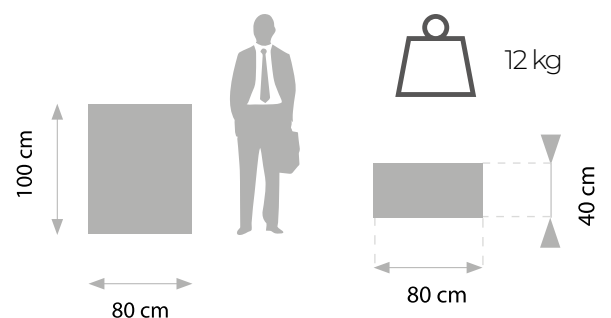



# COMPTOIR LED EXPO

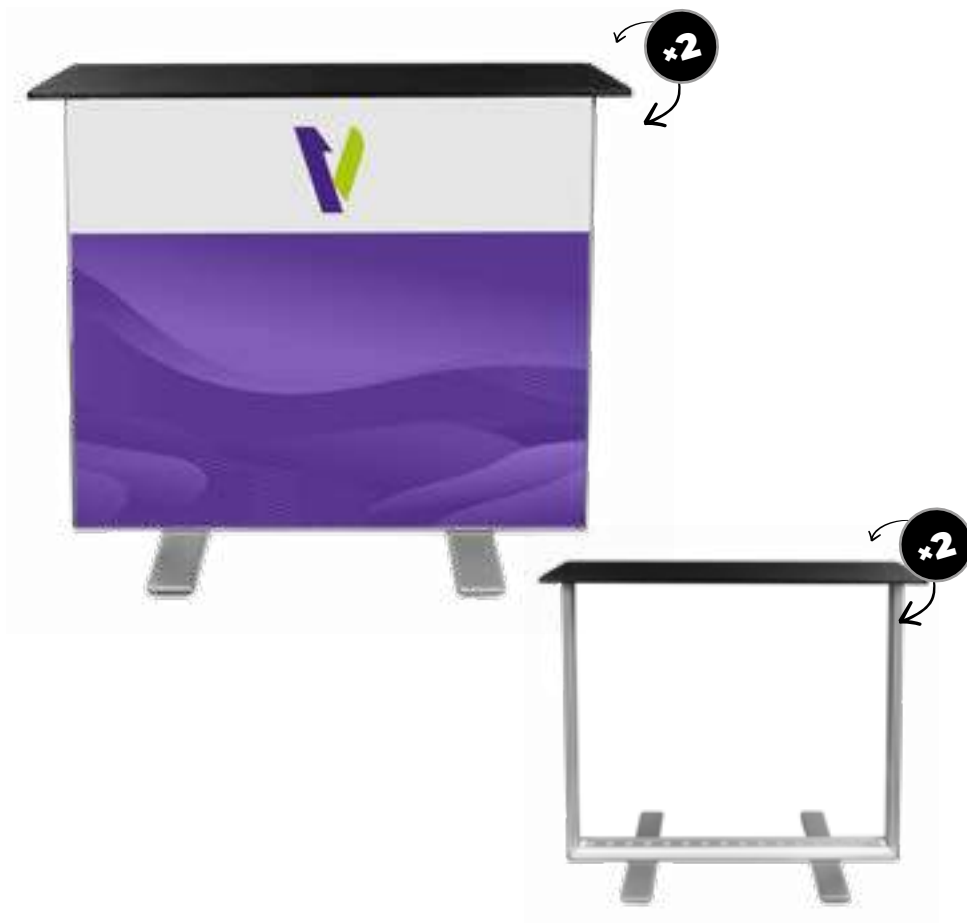

## LES AVANTAGES

- + Déploiement sans outils en 2 min
- + Accompagne les CADRES LED EXPO
- + Point d'accueil haut de gamme pour vos salons
- + Nomade avec sa housse de transport
- + Eclairage LED
- + Plateau bois
- + Qualité photo RECTO/VERSO
- + Fixation du visuel par jonc silicone / parfaitement tendue



LED



Connecteur rapide



Sans outils



Profile aluminium



Double face



Jonc silicone



## ⊕ CARACTÉRISTIQUES TECHNIQUES

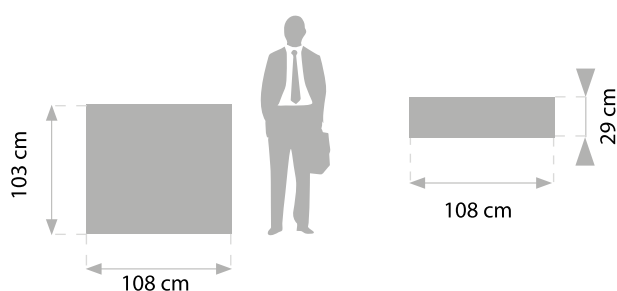



## SIGNALÉTIQUE INTÉRIEURE

---

- + Roll-up standard
- + Roll-up premium
- + Roll-up double faces
- + X banner de luxe
- + Suspension pop-up
- + Table flag

# ROLL UP STANDARD

# ROLL UP STANDARD BLACK



## LES AVANTAGES

- + Informe et accueil
- + Tissu polyester ou PVC
- + Léger et pratique
- + Qualité photo
- + Option noir aspect « haut de gamme »

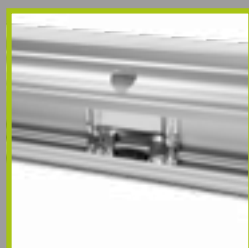

Base renforcée



Suspente a clip rapide

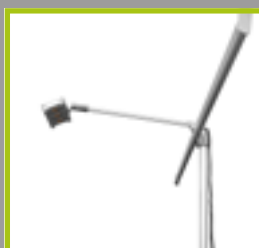

Option lampe LED



Zoom version noir



Sac de transport avec fenêtre pour carte de visite

## ⊕ CARACTÉRISTIQUES TECHNIQUES

Type	Taille de la structure : largeur x hauteur	Poids [kg]
Taille S	85x200	1,6
Taille M	100x200	1,9

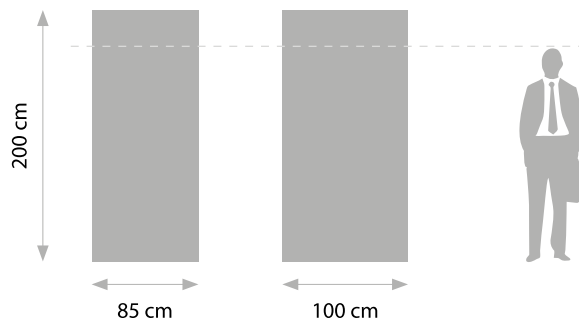

## MONTAGE EN 30 SEC

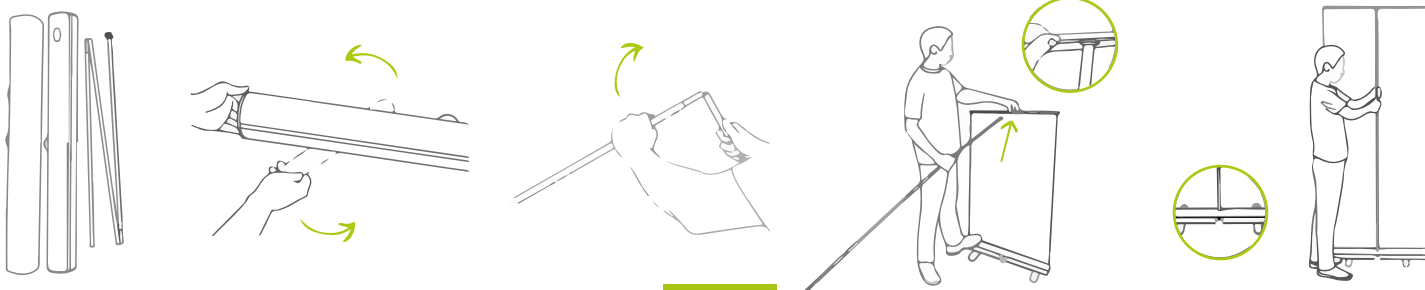

# ROLL UP PREMIUM



Eclairage LED en option

## LES AVANTAGES

- + Usage intensif avec carter renforcé
- + Informe et accueil
- + Tissu polyester ou PVC
- + Léger et pratique
- + Qualité photo
- + 5 tailles disponibles



Sac de transport



Ultra léger



Sans outils



Base renforcée

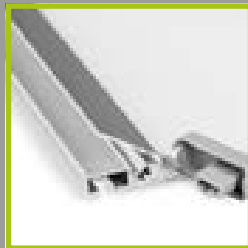

Suspente a clip rapide



Option lampe LED



Carter et flasque renforcée



Sac de transport avec fenêtre pour carte de visite

## ⊕ CARACTÉRISTIQUES TECHNIQUES

Type	Taille de la structure : largeur x hauteur	Poids [kg]
Taille S	80×200	2
Taille M	85×200	2,2
Taille L	100×200	2,7
Taille XL	120×200	3,5
Taille XXL	150×200	4

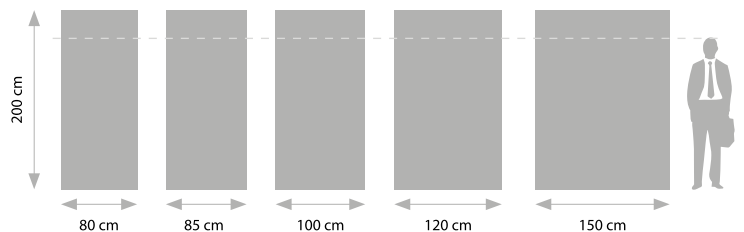

## MONTAGE EN 30 SEC





# ROLL UP DOUBLE FACES



## LES AVANTAGES

- + Usage intensif avec carter renforcé
- + Informe et accueil
- + Tissu polyester ou PVC
- + Léger et pratique
- + Qualité photo
- + Impression double faces

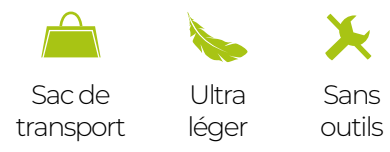

Carter et flasque double    
 Suspente a clip rapide    
 Option lampe LED    
 Double mats    
 Sac de transport avec fenêtre pour carte de visite

## ⊕ CARACTÉRISTIQUES TECHNIQUES

Type	Taille de la structure : largeur x hauteur	Poids [kg]
Taille S	85x200	4
Taille M	100x200	4,7

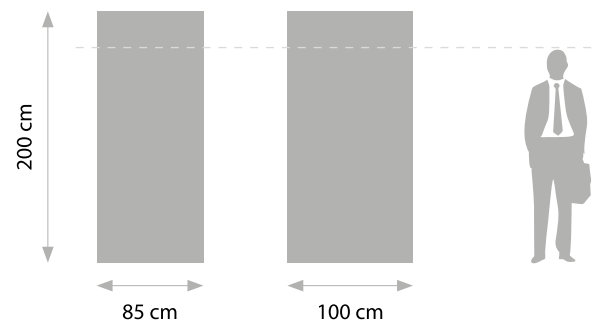

## MONTAGE EN 30 SEC

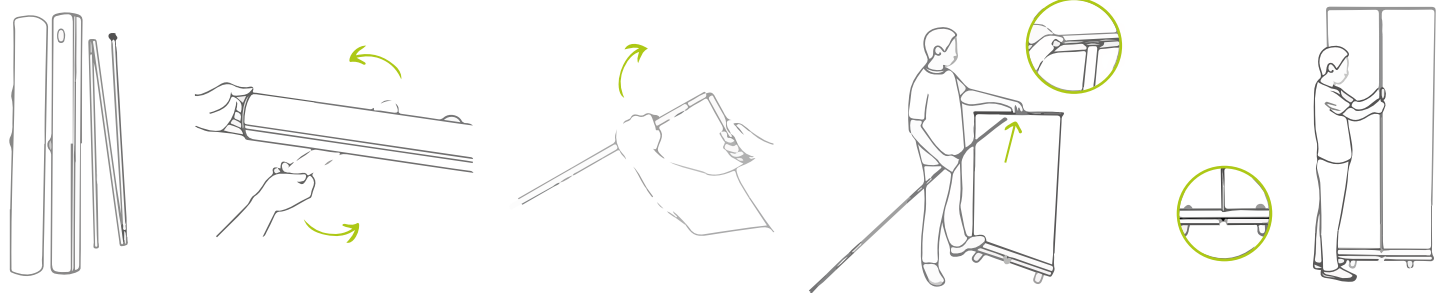

# X BANNER DE LUXE



## LES AVANTAGES

- + Habille votre stand
- + Léger et pratique
- + Intérieur ou extérieur
- + Impression numérique
- + PVC ou Toile polyester



Sac de transport



Ultra léger



Sans outils



Structure monobloc déployable pour une utilisation rapide



Mâts d'accroche en fibre de verre souple

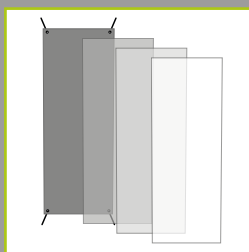

Visuel interchangeable



Sac de transport

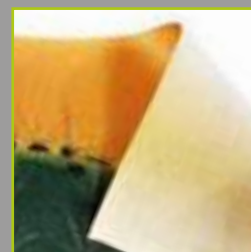

Tissu polyester ou bâche PVC

## ⊕ CARACTÉRISTIQUES TECHNIQUES

Type	Dimensions : largeur x hauteur x profondeur (cm)	Format visible de l'impression : largeur x hauteur (cm)	Poids [kg]
X-BANNER 80	85,5 x 195 x 95	80 x 180	1,4
X-BANNER 60	65,5 x 175	60 x 160	1,3

## MONTAGE EN 30 SEC

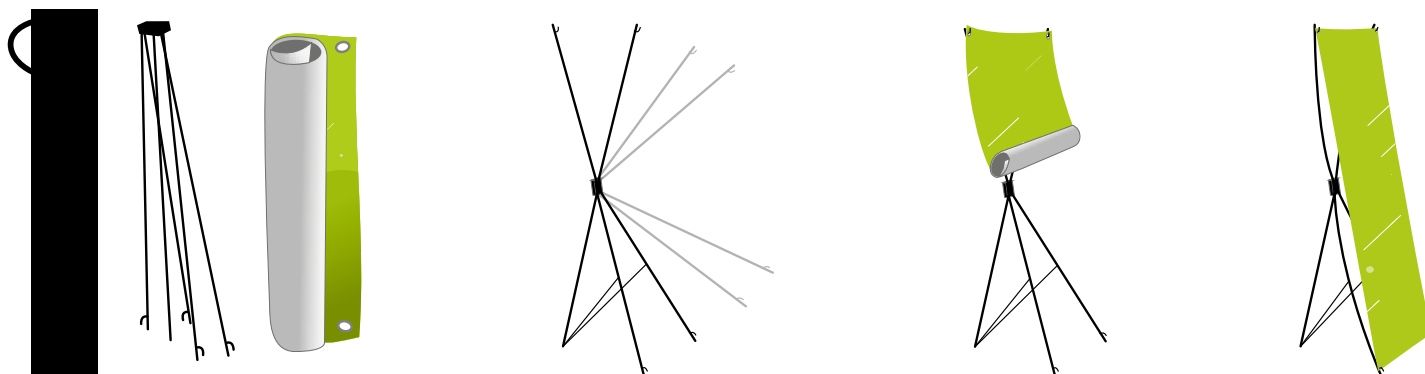

## SUSPENSION POP-UP

Prenez de la hauteur

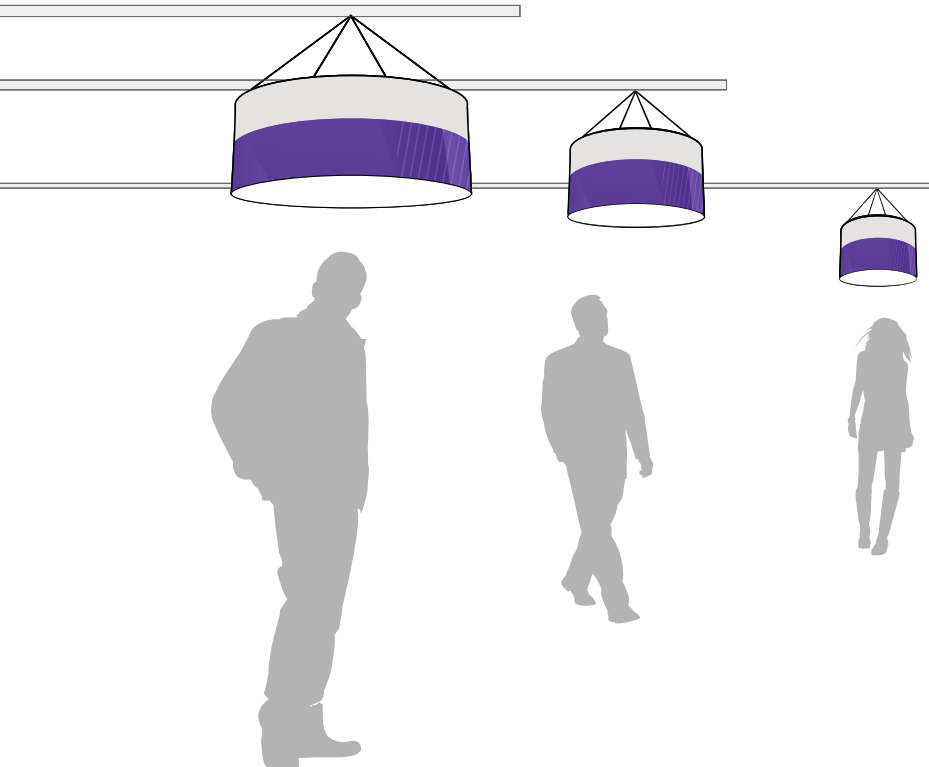

### LES AVANTAGES

- + Attire le regard de loin
- + Léger et pratique
- + Qualité photo
- + Visibilité 360°



Sac de transport



Ignifugé B1



Sans outils

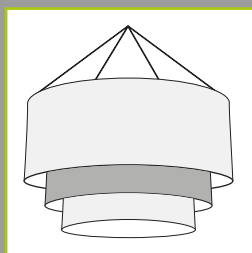

Modèles superposables pour aménager l'espace



Sac de rangement pour la transporter facilement

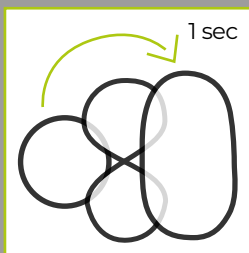

S'auto-déploie pour une installation instantanée

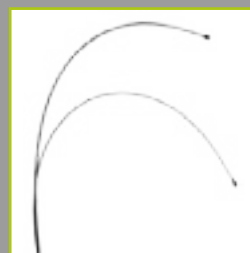

Structure en fibre de verre pour plus de souplesse dans le pliage



Polyester maille bloquée 200 g/m<sup>2</sup> avec impression par sublimation

### Forme Cylindrique

Structure pliable

Tailles en cm

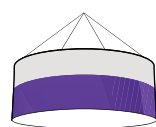

	S	M	L	XL
DIAMÈTRE	80	150	180	180
HAUTEUR	80	80	80	140

MONTAGE ET INSTALLATION  
5 SECONDES



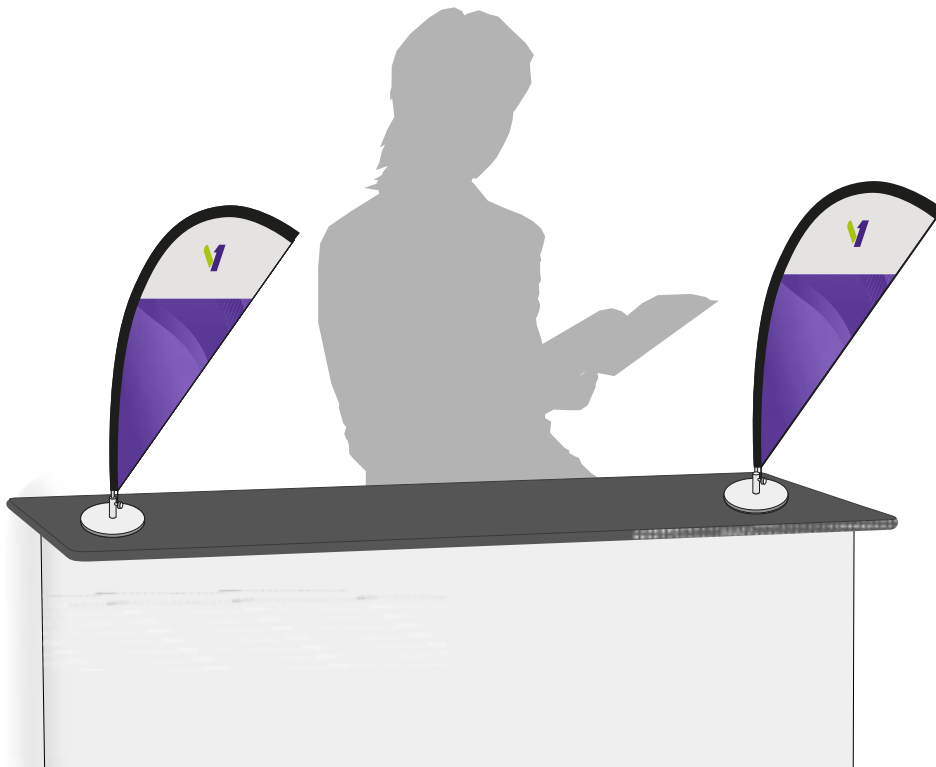

LES AVANTAGES

- + Attire le regard
- + Montage facile
- + Economique
- + Embase et sac inclus



Stabilité garantie grâce à son embase



Sommet renforcé pour protéger et enfiler la voile facilement

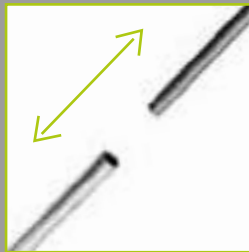

Mât emboîtable



Format mini pour le transporter facilement partout



Polyester maille bloquée 115 g/m<sup>2</sup> avec impression par sublimation

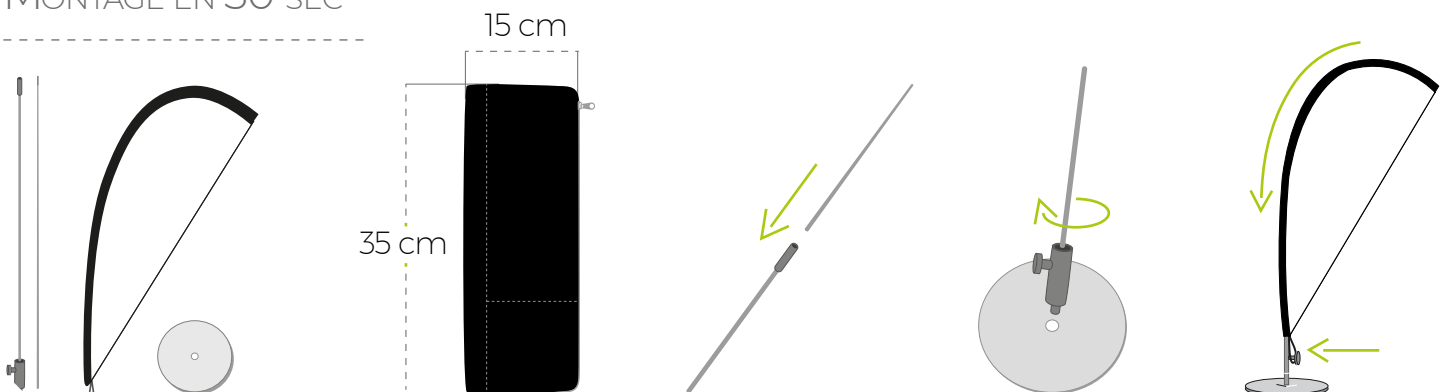

Table flag

Tailles en cm

HAUTEUR	48
LARGEUR	15

MONTAGE EN 30 SEC







## AFFICHAGE OUTDOOR

---

- + Stop trottoir ALU 32
- + Stop trottoir à lester
- + Stop trottoir 2 en 1
- + Housse pour barrière VAUBAN
- + Barrière sur cadre
- + Barrière Pop-up

# STOP TROTTOIR ALU 32



## LES AVANTAGES

- + Attire le regard
- + Stable (cadre sur ressort et pieds écartés) et poids de 8,8 kg
- + Résistant aux intempéries
- + Affichage recto/verso
- + Format A1
- + Changement rapide de l'affiche (cadre clic-clap)
- + Revêtement anti UV pour protéger l'impression de l'affiche



Ultra léger



Sans outils



Double face



Extérieur



Traitement anti-UV



Changement d'affiche rapide



## CARACTÉRISTIQUES TECHNIQUES

Type	Taille de la structure : largeur x hauteur	Poids [kg]
A1	59,4 x 84,1 cm	8,8

LE KIT COMPREND :  
UN CHEVALET STOP TROTTOIR, UNE BOÎTE EN CARTON INDIVIDUELLE.

## STOP TROTTOIR A LESTER ARGENT



### ⊕ CARACTÉRISTIQUES TECHNIQUES



Cadre clip-clap



Petites roulettes pour déplacer le module



Réservoir a remplir d'eau

## LES AVANTAGES

- + Attire le regard
- + Stable (cadre sur ressort et pieds écartés) et poids remplie d'eau 15 kg
- + Résistant aux intempéries
- + Affichage recto/verso
- + Format A1
- + Changement rapide de l'affiche (cadre clic-clap)
- + Revêtement anti UV pour protéger l'impression de l'affiche



Ultra léger



Sans outils



Double face



Extérieur



Traitement anti-UV



Changement d'affiche rapide

## STOP TROTTOIR A LESTER NOIR



Ultra léger



Sans outils



Double face



Extérieur



Traitement anti-UV



Changement d'affiche rapide



Ressort puissant contre les rafales de vent

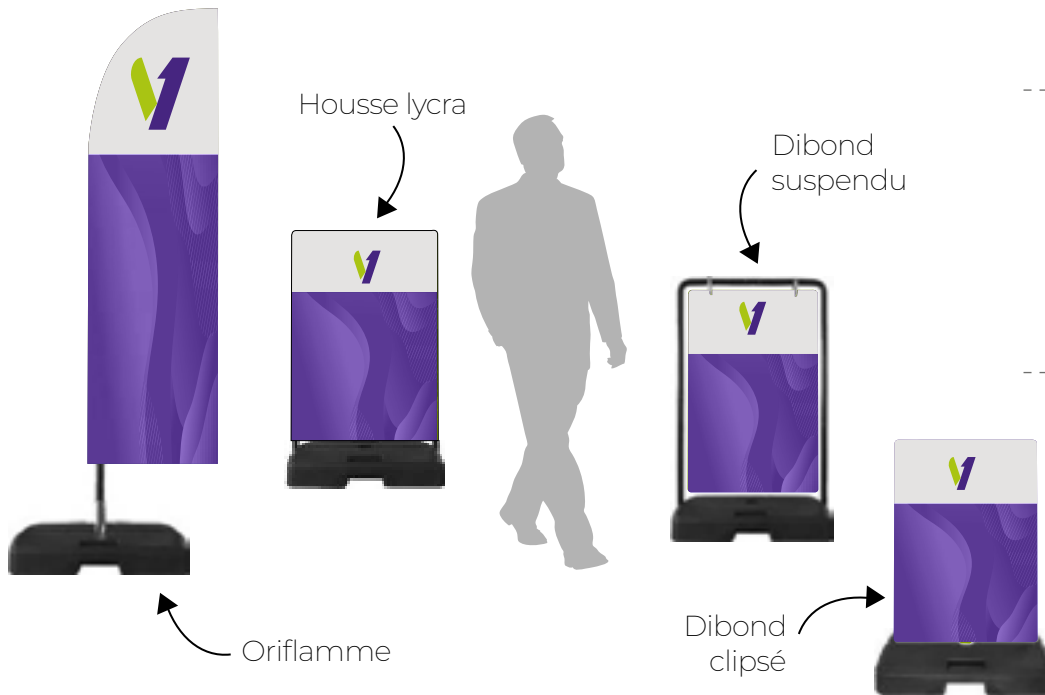

### LES AVANTAGES

- + Se déplace facilement
- + Visuel changeable
- + Impression HD
- + Intérieur ou extérieur

 Montage en 3 mn  
 Sans outils



Base 20L rotomoulée extra stable à remplir d'eau ou de sable

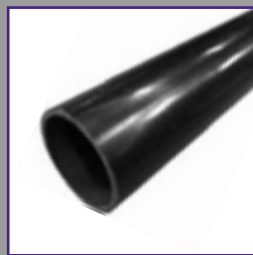

Tube en acier 5cm de diamètre à emboîter



Socle à roulettes avec poignée pour la mobilité



A assembler avec d'autres socles en croix pour lestage



Impression avec pelliculage effaçable Velleda possible

Tailles en cm	Structure	Oriflamme	Housse	Dibond suspendu	Dibond clipsé
LARGEUR	70	50	70	59	59
HAUTEUR	120	175	95	84	84
EFFAÇABLE	-	X	X	✓	✓

### MONTAGE EN 3 MINUTES

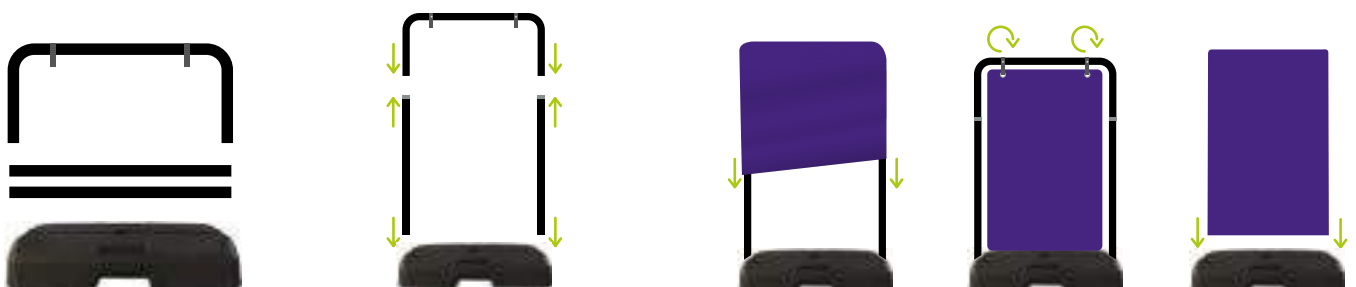



# HOUSSE POUR BARRIÈRES VAUBAN

## CARACTÉRISTIQUES TECHNIQUES

- + Format sur mesure adaptés aux tailles des barrières
- + Impression sur textile polyester
- + Impression numérique par sublimation thermique
- + Produit idéalement destiné pour l'événementiel
- + Montage facile – fermeture par velcro



POSSIBILITÉ D'IMPRIMER DES VISUELS DIFFÉRENTS SUR LES DEUX CÔTÉS DE LA HOUSSE

# BARRIÈRES SUR CADRE

## LES AVANTAGES

- + Montage simple et rapide
- + Balise/délimite l'espace
- + Qualité photo
- + Segment emboîtable sur palette
- + Polyester 115g/m<sup>2</sup> ou bâche PVC 500g/m<sup>2</sup>



Facile à monter



Résiste au vent



Sans outils

	Taille en cm	
	2m	3m
Structure	200x100	300x100
Visuel	200x90	300x90



# BARRIÈRE POP-UP



## LES AVANTAGES

- + Montage simple et rapide
- + Balise et habille l'espace
- + Qualité photo
- + Nomade et léger



Impression double face pour une meilleure visibilité



Sac de rangement pour le transporter facilement



Tissu polyester 200g/m<sup>2</sup> avec impression par sublimation

## ATOUTS

- + Disponible en 3 formats
- + Impression sur tissu polyester
- + Transport et stockage faciles (sac fourni)
- + Nomade et léger

## CARACTÉRISTIQUES TECHNIQUES

Type	Format largeur x hauteur [cm]	Produit emballé dans son sac [cm]	Poids [kg]
S	140 x 70	Ø 65	2,7
M	200 x 90	Ø 85	3,7
L	250 x 100	Ø 100	4,7

## MONTAGE ET DÉMONTAGE EN 5 SECONDES







## IMPRESSION GRAND FORMAT

- + Kakemono a suspendre
- + Tifo / fond de scène
- + Pavillonnerie / drapeau publicitaire
- + Impression bâche pvc blackout & backlight
- + Impression bâche pvc & micro perforée
- + Impression tissus polyester & intissé
- + Impression film vinyle autocollant & stickers de sol
- + Impression pvc dibond, pvc akilux, pvc forex

# KAKEMONO A SUSPENDRE



## FINITION



Haut



Bas



Double cotures sur les côtés

## LES AVANTAGES

- + Sur mesure ou standard
- + Résistant sur la durée
- + Possibilité d'imprimer en haute résolution sur divers matériaux

## DIFFERENTES TAILLES

Taille en cm	Largeur	Hauteur
M	80	200
L	100	200

# TIFO - FOND DE SCENE

- + Impression numérique par sublimation
- + Impression sur polyester 110g ou polydéco 210g
- + Parfait pour l'extérieur
- + Possibilité de réaliser des impressions en très grands formats
- + Type de finition en accord avec la demande du client
- + Sur devis au m<sup>2</sup>





## LES AVANTAGES

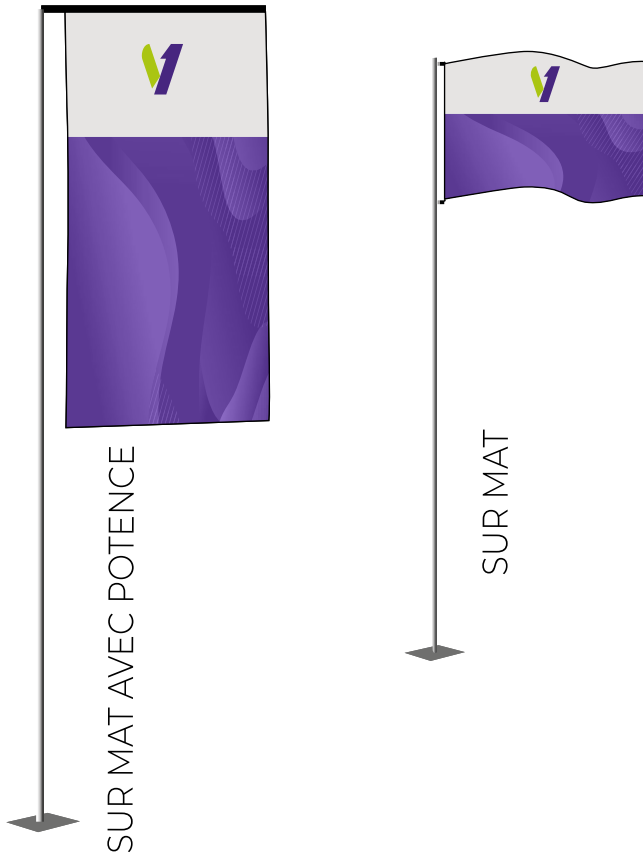

- + Sur mesure ou standard
- + Intérieur et extérieur
- + Nombreuses finitions
- + Impression sublimation
- + Simple - excellente traversée de l'encre au verso
- + Format sur mesure à la demande
- + Impression sur maille polyester 110gr/m<sup>2</sup>
- + Finition possible pour une installation avec ou sans potence
- + Bas et côté droit : ourlet conçu deux files

## CARACTÉRISTIQUES TECHNIQUES

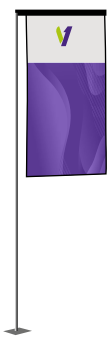

### Sur mât avec potence

Taille en cm	Largeur	Hauteur
S	80	120
M	100	150
L	100	300
XL	150	400



### Sur mât

Taille en cm	Largeur	Hauteur
S	80	120
M	150	100
L	100	300
XL	150	400

## ATOUTS



Jonc à tête ronde



Fourreau

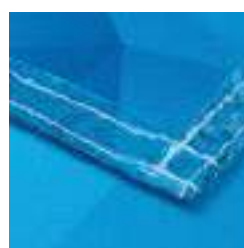

Coutûre deux lignes



Ajout d'une sangle de renfort + mousqueton

# Impression Bâche PVC BLOCKOUT

Parfaitement opaque

## ⊕ CARACTÉRISTIQUES TECHNIQUES

- + 610g/m<sup>2</sup>
- + Composé d'un film opacifiant
- + S'adapte aux impressions en Recto/Verso
- + Haute qualité d'impression et bonne résistance aux déchirures, ne s'effiloche pas
- + Bâche enduite avec finition mat, caractérisée par un excellent blocage du passage de la lumière
- + Tout formats et finitions possible
- + Utilisable en intérieur et extérieur



## ▮ FAÇONNAGES STANDARD



Découpe au format



Ourlet soudé +  
oeillets tout les 50cm



Fourreau soudé



Jonc à tête ronde



# Impression Bâche PVC BACKLIGHT

Parfaitement diffusant pour les caissons lumineux

## ⊕ CARACTÉRISTIQUES TECHNIQUES

- + 450g/m<sup>2</sup>
- + Bâche enduite avec finition mat, caractérisée par une excellente dispersion et diffusion de la lumière
- + Impression UV recto/verso ou double faces
- + Largeur maximale d'une laize graphique - 495cm
- + Tissu résistant aux dommages mécaniques et usures (déchirement, humidité, températures extrêmes)

## ▮ FAÇONNAGES STANDARD



Découpe au format



Jonc silicone



Fourreau soudé



# Bâches PVC

*Résistante et durable*

## ⊕ CARACTÉRISTIQUES TECHNIQUES

- + Tous formats et finitions possibles :
  - 450g/m<sup>2</sup>
  - 510g/m<sup>2</sup>
- + Largeur maximale d'une laize graphique - 500cm
- + Permet d'obtenir une impression UV de haute qualité



## ▣ FAÇONNAGES STANDARD



Ourlet soudé + oeillets



Jonc à tête ronde



Velcros



Fourreau soudé

D'AUTRES FINITIONS SONT POSSIBLES SUR DEMANDE DU CLIENT

# Bâches PVC MICRO PERFORES

*Laisse passer la lumière et le vent*

## ⊕ CARACTÉRISTIQUES TECHNIQUES

- + Tous formats et finitions possibles
- + Matériau: bâche PVC micro-perforée de type «grille»
- + Largeur maximale d'une laize graphique - 500cm
- + Idéal pour communiquer sur de grands format fixé aux bâtiments
- + Beaucoup plus léger que la bâche frontlit ou backlit laisse passer la lumière
- + Souvent installé sur des échafaudages



## ▣ FAÇONNAGES STANDARD

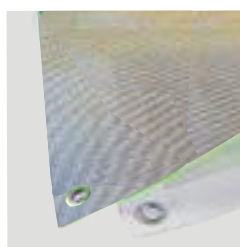

Ourlet soudé + oeillets

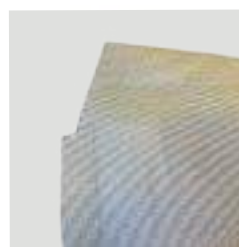

Fourreau soudé



Jonc à tête ronde

## ⊕ CARACTÉRISTIQUES TECHNIQUES

- + Différents formats disponible
- + Polydéco 210g/m<sup>2</sup> ou Maille polyester 115g/m<sup>2</sup>
- + Impression numérique par sublimation thermique
- + Produit pouvant être destiné à différents usages (drapeau, banderole)
- + Utilisées surtout dans l'événementiel



## ▮ FINITION

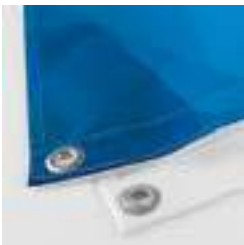

Bande de renfort polyester +oeillets



Fourreau



Découpe au format

## ⊕ CARACTÉRISTIQUES TECHNIQUES

- + Tissu intissé renforcé 130gr/m<sup>2</sup>
- + Tissu léger et résistant
- + Impression numérique par sublimation
- + Oeillet tous les 100cm



## ▮ ATOUTS

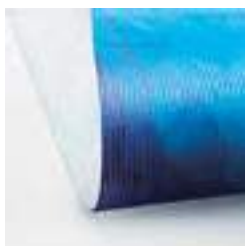

Tissu léger et résistant



Découpe au format +oeillets

RÉALISATION DE ROULEAUX IMPRIMÉ DE PLUSIEURS DIZAINES DE MÈTRES





# FILM VINYLE AUTOCOLLANT

## CARACTÉRISTIQUES TECHNIQUE

- + Plusieurs formats disponible
- + S'adapte à tout types de surfaces
- + Idéal pour habiller vos vitrines de magasins, stands de salons, cloison et panneaux publicitaires ou voitures
- + Monomère 125g/m<sup>2</sup>
- + Option lamination



# STICKERS DE SOL

*Pour imprimer vos sols en intérieur et extérieur*

## CARACTÉRISTIQUES TECHNIQUES

- + Adhésif monomère laminé
- + Plusieurs types de formats possibles
- + Matériaux résistants aux chocs mécaniques et détergents
- + Bonne qualité d'impression
- + Bonne adhésion sur les surfaces lisses
- + Impression UV
- + Anti-dérapant



### ATOUTS



Découpe à la forme possible



Bords protégés avec une feuille laminée



Surface antidérapante

# PVC DIBOND

*Pour les enseignes extérieures*

## CARACTÉRISTIQUES TECHNIQUES

- + Dimension de plaque : 305x150cm, 405x150cm et 3mm d'épaisseur
- + Matériel : Plaque composite rigide et esthétique composée de couches d'aluminium et de polyéthylène LPDE
- + Matériel plat, durable et résistant aux conditions météorologique
- + Personnalisable

### FINITION

- Fraisage au format où à la forme de l'impression
- Pliage

### ATOUTS



Fraisage de différentes formes



Fraisage angulaire



Pliage



RESISTE  
AUX CONDITIONS  
MÉTÉOROLOGIQUES

# PVC AKILUX

*Pour la communication légère en extérieur*

## CARACTÉRISTIQUES TECHNIQUES

- + Dimension de plaque : 300x200cm
- + Matériel léger, bonne alternative au carton
- + Imperméable
- + Résistant aux conditions météorologique
- + Possibilité de pose d'oeillets (3mm)
- + Polypropylène alvéolaire 3mm

### ATOUTS



Découpe au format ou à la forme



Possibilité de poinçonnage et de pliage



Matériel imperméable

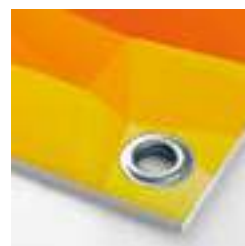

Possibilité de pose d'oeillets



MATÉRIAU LÉGER  
ÉCONOMIQUE

## ⊕ CARACTÉRISTIQUES TECHNIQUES

- + Différents formats possible
- + Intérieur ou extérieur
- + PVC expansé 3mm
- + Matériaux imperméables, résistant aux produits chimiques, difficilement inflammable et insonorisant



## ⊕ FINITION

- + Découpe/ fraisage au format ou à la forme de l'impression
- + Pliage

## ⊕ ATOUTS



Panneau fraisé



Thermo-pliage



Impression en recto-verso



## SIGNALÉTIQUE ET AMÉNAGEMENT D'ESPACES

---

### + SUPPORT D'AFFICHES A POSER

- + Porte brochure
- + Porte brochure-comptoir
- + Chevalet
- + Porte affiche sur pied
- + Cadre sur pied

### + AFFICHAGE

- + Profil porte affiche
- + Cadre suspendu
- + Cadre alu d'affichage
- + Cadre d'affichage  
magnétique
- + Plaque de porte clip/clap
- + Affichage plexi de comptoir

### + ARDOISE

- + Chevalet ardoise outdoor
- + Chevalet ardoise indoor
- + Tableau ardoise
- + Ardoise de comptoir
- + Marqueur a craie liquide

### + GUIDAGE

- + Poteaux de guidage  
avec sangle
- + Panneau pour poteau  
de guidage



## PORTE BROCHURES ARGENT / NOIR



### LES AVANTAGES

---

- + Distribution des brochures sur les 2 cotés
  - + Pour format A4
  - + Léger 5,2 Kg et pratique
  - + Transportable dans sa valise renforcée
  - + Disponible en argent et noir
- 

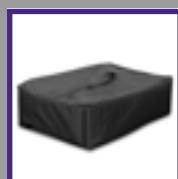

## PORTE BROCHURES-COMPTOIR



### LES AVANTAGES

---

- + 2 EN1: Comptoir et porte brochures
  - + Pour format A4
  - + Léger 8 Kg et pratique
  - + Transportable dans sa valise renforcée
  - + Plateau élégant en bois
-

## CHEVALET ARGENT / NOIR



### ⊕ CARACTÉRISTIQUES TECHNIQUES



Cadre clip-clap

### LES AVANTAGES

- + Distribution des brochures sur les 2 cotés
- + Accueille les formats A4
- + Léger 5,2 Kg et pratique
- + Transportable dans sa valise renforcée
- + Disponible en argent et noir

⊕ **LE KIT COMPREND :**  
**UN CHEVALET STOP TROTTOIR, UNE BOITE EN CARTON INDIVIDUELLE.**

## PORTE AFFICHE SUR PIED



### LES AVANTAGES

- + Attire le regard
- + Affichage recto/verso format A4
- + Changement rapide de l'affiche grâce à un panneau coulissant
- + Aluminium 25 mm



## CADRE SUR PIED ARGENT / NOIR

### LES AVANTAGES

- + Profil large (aluminium) : 25 mm
- + Design élégant socle en fer
- + Possibilité de positionner le cadre verticalement ou horizontalement
- + Changement rapide de l'image à l'aide des bords du cadre (clic-clac)
- + Destiné entre autres, pour afficher les menus de restaurants, indiquer les directions, présenter les plaques d'information, etc.

 **LE KIT COMPREND :**  
**UN SUPPORT PREMIUM, UNE BOÎTE EN**  
**CARTON INDIVIDUELLE.**

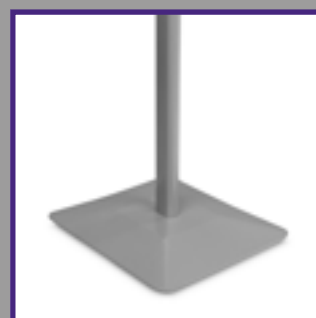
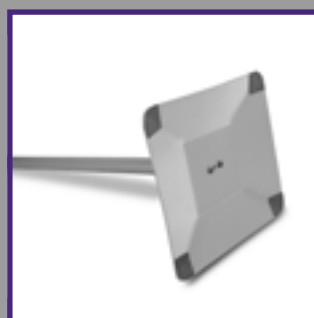
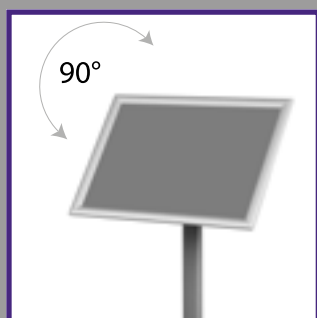

## PROFILES PORTE AFFICHE



### ⊕ CARACTÉRISTIQUES TECHNIQUES



### LES AVANTAGES

- + Possibilité de fixation au mur ou au plafond
- + Système à clip pour un montage et un remplacement rapide et facile des affiches
- + Aspect élégant
- + Profilé épais en aluminium anodisé

### ⊕ CARACTÉRISTIQUES TECHNIQUES

Type	Poids [kg]
40 cm	0,2
60 cm	0,3
85 cm	0,4
100 cm	0,45
120 cm	0,55
150 cm	0,70

## CADRE SUSPENDU



### LES AVANTAGES

- + Fixation au plafond par des câbles en acier
- + Système de fixation Clip-clap pour un montage et un remplacement rapide et facile des affiches
- + Aspect élégant
- + Profilé épais en aluminium anodisé
- + Format A1, A2, B1, B2
- + Visibilité Recto/verso





## CADRE ALU D’AFFICHAGE ARGENT/NOIR



### ✚ CARACTÉRISTIQUES TECHNIQUES

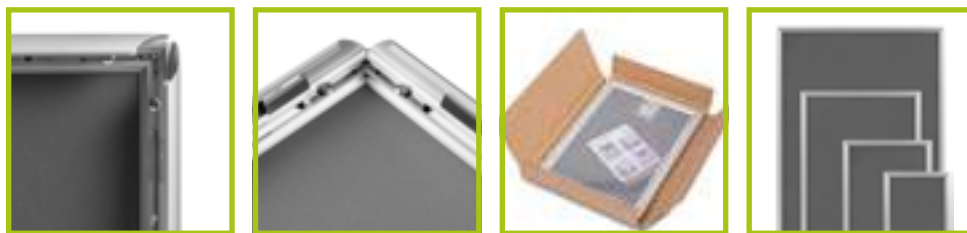

### LES AVANTAGES

- ✚ Possibilité de fixation au mur vertical ou horizontal
- ✚ Couche avec filtre UV protégeant l'impression de la perte de couleurs
- ✚ Système à clip pour un montage et un remplacement rapide et facile des affiches
- ✚ Aspect élégant
- ✚ Profilé épais en aluminium anodisé 25 mm

Type	Poids [kg]
A4	0,45
A3	0,65
A2	1,15
A1	1,90
B3	0,95
B2	2
B1	2,6

## CADRE D’AFFICHAGE MAGNETIQUE ARGENT / NOIR

Montage par l'avant



Montage Recto/verso  
(pour vitrines)

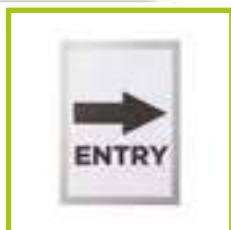

### LES AVANTAGES

- ✚ Design simple et élégant
- ✚ le film brillant anti-reflet maintient l'impression à l'aide de bandes magnétiques
- ✚ Sans outils
- ✚ Format A3 et A4

Cadre d'avertissement avec aimant imprimé



## PLAQUE DE PORTE CLIP CLAP



### LES AVANTAGES

- + L'une des plaques de porte les plus populaires sur le marché
- + Rapidité de changement de l'étiquette (cadre clic-clap)
- + Film anti-reflet inclus
- + La plaque peut être montée à l'aide des vis incluses dans le kit ou avec du ruban adhésif double face
- + Format A4, A5, A6

## CADRE DE COMPTOIR PLEXI HORIZONTAL



### LES AVANTAGES

- + Support en Acrylique solide avec un large pied
- + Design exceptionnellement élégant
- + Visibilité Recto/verso
- + Format A4, A5, A6

## CADRE DE COMPTOIR PLEXI VERTICAL



### LES AVANTAGES

- + Support en Acrylique solide avec un large pied
- + Design exceptionnellement élégant
- + Visibilité Recto/verso
- + Format A4, A5, A6

## CHEVALET ARDOISE INDOOR ET OUTDOOR



Couleurs:

Lot de 8 marqueurs à craie liquide, pour écrire sur tableau noir.  
Une excellente alternative à la craie traditionnelle poussiéreuse.

### LES AVANTAGES

- + Profil large: 35 mm
- + 2 dimensions : 51 X 90 cm et 161 X 118 cm
- + Cadre élégant en bois
- + Design polyvalent - s'adapte à tous les espaces
- + La surface d'écriture sous forme de tableau noir est idéale pour la restauration et les espaces commerciaux
- + Profil large : 60 mm
- + Dimension : 65 X 118 cm
- + Résistant aux intempéries grâce à une couche de vernis
- + Production européenne
- + Stabilité assurée par le poids – 21 kg
- + Chaîne argentée fixant les pieds



### LES AVANTAGES

- + Tableau noir à craie avec surface d'écriture en panneau HDF
- + Résistant, recouvert d'un vernis spécial.
- + Profil du cadre de 3,5 cm.
- + Peut être accroché verticalement ou horizontalement.
- + Dimensions : 47 X 60 cm , 47 X 69 cm, 60 X 87 cm, 80 X 100 cm

## ARDOISE



## ARDOISE DE COMPTOIR



### LES AVANTAGES

- + Surface à craie (HDF résistant) permet un changement facile et rapide des informations notées.
- + Le socle en bois garantit la stabilité du produit et son aspect élégant
- + Dimensions A6, A5, A4

## ARDOISE DE COMPTOIR



### LES AVANTAGES

- + Lot de 8 marqueurs à craie liquide, pour écrire sur les tableaux noirs. Une excellente alternative à la craie traditionnelle poussiéreuse.
- + Lavable à l'eau

## POTEAU DE GUIDAGE NOIR / CHROME / BLANC

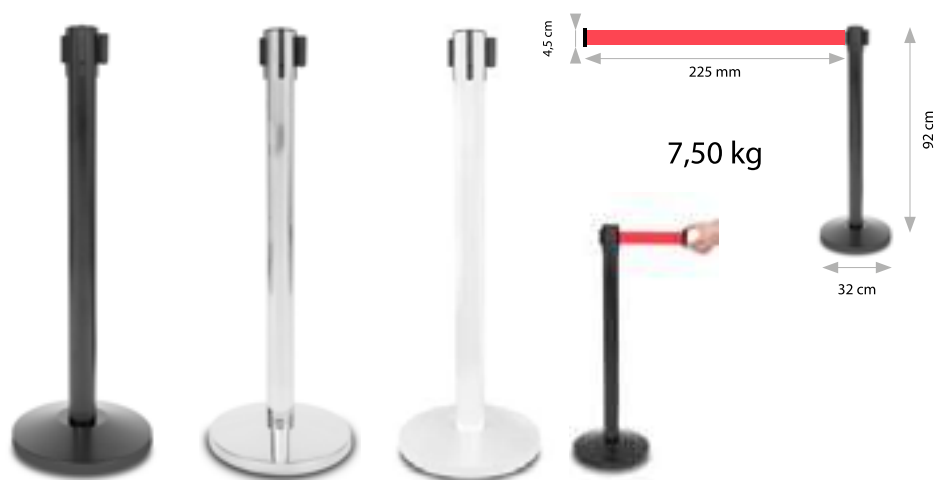

### LES AVANTAGES

- + Haute qualité avec enrouleur de sangle automatique intégré au poteau.
- + Très stable avec un poids de 7,5kg et avec une sangle longue de 225 cm
- + La sangle type « ceinture de sécurité de voiture ».
- + Le matériau est exceptionnellement solide et durable et il ne s'effilochera jamais.

## SANGLE POUR POTEAU DE GUIDAGE



## PANNEAU D'AFFICHAGE POUR POTEAU DE GUIDAGE CHROME / NOIR



### LES AVANTAGES

- + Panneau d'information double face au format A4, fixé sur un poteau de guidage









## MOBILIER ÉVÉNEMENTIEL

---

- + Mange debout
- + Table pliante 180
- + Affichage table pliante 180
- + Table ronde 122
- + Housse lycra
- + Nappes
- + Visuel d'affichage pour table pliante 180
- + Chaise pliante basse
- + Chaise pliante haute
- + Housses lycra pour chaise haute
- + Parasol
- + Transat chilienne



## LES AVANTAGES

- + Transport et stockage facile
- + Installation en 3 secondes
- + Idéal pour les événements
- + Housse personnalisable
- + Housse en matière polyester élastique recyclable



Housse en lycra imprimée pour les mange debout

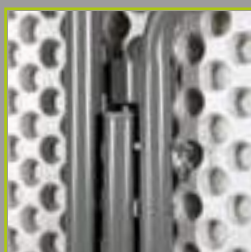

Construction en acier



Plateau en PEHD  
80cm



Blocage de la structure

## ⊕ CARACTÉRISTIQUES TECHNIQUES

Type	Dimensions de la table : diamètre x hauteur [cm]	Taille de la structure : diamètre x hauteur [cm]	Dimensions de l'emballage : largeur x hauteur x profondeur [cm]	Poids [kg]
Table A80	ø 80	80 x 109	81 x 136 x 5	11



## TABLE PLIANTE 180



### LES AVANTAGES

- + Transport et stockage facile
- + Installation en 3 secondes
- + Polyéthylène + acier
- + Poignée spéciale pour le transport
- + Dimensions 180 X 85 cm, poids 12 kg

## AFFICHAGE POUR TABLE



### LES AVANTAGES

- + Structure polyvalente à viser sur les tables de 180 cm
- + Communication facile avec un visuel qui s'enfile comme une chaussette
- + Permet de créer un stand, un espace d'exposition à moindre frais

## TABLE RONDE 122



### LES AVANTAGES

- + Transport et stockage facile
- + Installation en 3 secondes
- + Polyéthylène + acier
- + Poignée spéciale pour le transport
- + Dimensions 122 cm poids 11 kg



## HOUSSE LYCRA NOIR/BLANC/IMPRIMEE



### LES AVANTAGES

- + Parfaitement tendu avec le tissu lycra élastique
- + Lavable en machine
- + Communication facile avec un visuel qui s'enfile comme une chaussette

## NAPPES IMPRIMEE TABLE 180 / TABLE RONDE 122



### LES AVANTAGES

- + Habille élégamment les tables ne touche pas le sol
- + Espace disponible pour les jambes en configuration repas

## VISUEL D'AFFICHAGE POUR TABLE PLIANTE 180 - BANDEAU / MUR



### LES AVANTAGES

- + Communication facile avec un visuel qui s'enfile comme une chaussette
- + Permet de créer un stand, un espace d'exposition à moindre frais

## CHAISE PLIANTE BASSE



### LES AVANTAGES

---

- + Construction légère et stable
  - + Polyéthylène et acier
  - + Patins antidérapants
  - + Pliable
  - + Poids 4,5 kg
- 

## CHAISE PLIANTE HAUTE



### LES AVANTAGES

---

- + Adapté aux manges debout
  - + Construction légère et stable
  - + Polyéthylène et acier
  - + Patins antidérapants
  - + Pliable
  - + Poids 5,5 kg
- 

## HOUSSES LYCRA POUR CHAISE HAUTE



### LES AVANTAGES

---

- + Parfaitement tendu avec le tissu lycra élastique
  - + Lavable en machine
-

# PARASOL



## LES AVANTAGES

- + Polyester 220g/m<sup>2</sup>
- + Intérieur ou extérieur
- + Léger et pratique
- + Qualité photo

## ⊕ CARACTÉRISTIQUES TECHNIQUES

Type	Forme	Format [cm]	Hauteur [cm]	Dimensions de l'emballage : largeur x hauteur x épaisseur [cm]	Poids [kg]
Type	Octogonale	180	jusqu'à 230	15 x 15 x 125	4
Lestage parasol	Carrée	40 x 40	12/25	42 x 42 x 17	3

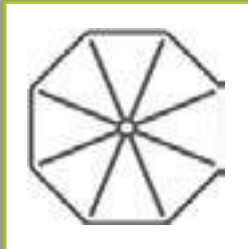

Toit composé de 8 pans imprimables



Structure acier blanc inclinable



Pied parasol à remplir 10L

# TRANSAT



## LES AVANTAGES

- + Crée une ambiance décontractée
- + Habille votre stand
- + Intérieur ou extérieur
- + Léger et pratique

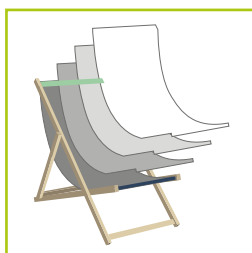

Visuel interchangeable



Structure en bois



3 positions de réglage d'inclinaison.

# Instructions pour créer et nous transmettre vos visuels

## Logos et dessins d'aplats de couleurs

- Logo vectorisé sur nos gabarits
- Format colorimétrique CMJN
- Polices vectorisées
- Références Pantone Couché
- Fichier au format PDF à l'échelle 1/1 (ou à l'échelle du gabarit fourni)

## Visuel photo

- Format colorimétrique CMJN
- Textes pixellisés
- Références Pantone Couché
- Résolution minimale de 150 DPI à l'échelle 1/1
- Fichier au format PSD ou PDF à l'échelle 1/1 (ou à l'échelle du gabarit fourni)

## Envoyer vos fichiers

- Fichier inférieur à 10 Mo  
Par mail à : [yann@v1-pro.com](mailto:yann@v1-pro.com)
- Fichier supérieur à 10 Mo  
Par Wetransfer à : [yann@v1-pro.com](mailto:yann@v1-pro.com)





Simplifiez-vous la vie !



2025